

## Errata

**Title & Document Type:** 16500B Users Reference

**Manual Part Number:** 16500-97010

**Revision Date:** April 1994

---

### HP References in this Manual

This manual may contain references to HP or Hewlett-Packard. Please note that Hewlett-Packard's former test and measurement, semiconductor products and chemical analysis businesses are now part of Agilent Technologies. We have made no changes to this manual copy. The HP XXXX referred to in this document is now the Agilent XXXX. For example, model number HP8648A is now model number Agilent 8648A.

### About this Manual

We've added this manual to the Agilent website in an effort to help you support your product. This manual provides the best information we could find. It may be incomplete or contain dated information, and the scan quality may not be ideal. If we find a better copy in the future, we will add it to the Agilent website.

### Support for Your Product

Agilent no longer sells or supports this product. You will find any other available product information on the Agilent Test & Measurement website:

[www.tm.agilent.com](http://www.tm.agilent.com)

Search for the model number of this product, and the resulting product page will guide you to any available information. Our service centers may be able to perform calibration if no repair parts are needed, but no other support from Agilent is available.

---

# User's Reference

Publication number 16500-97010  
First edition, April 1994

For Safety information, Warranties, and Regulatory  
information, see the pages behind the index

© Copyright Hewlett-Packard Company 1987, 1990, 1993, 1994  
All Rights Reserved

---

HP 16500B /16501A  
Logic Analysis System



---

## In This Book

Welcome to the Hewlett-Packard Logic Analysis System! The HP 16500B Logic Analysis System is designed to be the easiest system to use, ever. Its modular design allows you to configure it with just the measurement modules you need now, yet add other modules later.

This reference explains the operation of the system mainframe and intermodule menus. Also included is information on the most common system options.

### Organization

When you order the HP 16500B, you get two binders (one is extra for later use). The mainframe reference information is found behind the first tab "HP 16500B Mainframe."

Information on the optional keyboard, mouse, and the HP 16501A Expansion Frame is found behind the second tab, "System Options." As you accumulate other system options, place these references behind this tab.

Behind the third tab "Common Module Operations" is information common to most modules, like installing modules, using symbols, and assigning labels.

As you purchase additional measurement modules, place their references at the back of this binder or in the second binder.

<b>1</b>	<b>What is the HP 16500B Logic Analysis System</b>	
<b>2</b>	<b>System Configuration Menu</b>	
<b>3</b>	<b>The HP-IB and RS-232C Interfaces</b>	
<b>4</b>	<b>Connecting a Printer</b>	
<b>5</b>	<b>Disk Drive Menus</b>	
<b>6</b>	<b>System Utilities Menu</b>	
<b>7</b>	<b>Intermodule Measurements</b>	
<b>8</b>	<b>General Characteristics</b>	
<b>9</b>	<b>Maintaining the HP 16500B</b>	
<b>10</b>	<b>Error Messages</b>	
	<b>Index</b>	

### **What is in the HP 16500B User's Reference?**

- Chapter 1 introduces the HP 16500B by summarizing its features.
- Chapter 2 describes the mainframe's System Configuration menu.
- Chapter 3 describes the HP-IB and RS-232C interfaces. They are used for printing screens and computer controlled measurements.
- Chapter 4 explains how to print screens to various graphics printers.
- Chapter 5 describes the flexible disk and hard disk operations.
- Chapter 6 describes the System Utilities menu. Adjustments to the real-time clock, touch calibration, and screen colors are made here.
- Chapter 7 explains how to make intermediate measurements.
- Chapter 8 lists the instrument specifications and characteristics.
- Chapter 9 explains the general instrument maintenance and repacking information. Also included is a description of the self-test that is performed when the instrument is turned on.
- Chapter 10 describes all system and disk error messages.

### **What is in the System Options?**

- Chapter 1 explains the keyboard and mouse options.
- Chapter 2 describes the HP 16501A Expansion Frame option. Even though you may not have purchased these options yet, keep this information for possible future use.

### **What is in the Common Module Operations?**

- Chapter 1 describes assigning labels.
- Chapter 2 describes using symbols.
- Chapter 3 explains the general installation for individual modules.

### **Where to go next**

If you haven't already read *Setting Up The HP 16500 Logic Analysis System*, please read it before continuing.

MS-DOS<sup>®</sup> is a US registered trademark of Microsoft Corporation.

**HP 16500B  
Mainframe**

**1 What Is the HP 16500B Logic Analysis System ?**

- Key Features 1-3
- Optional Features 1-3
- User Interfaces 1-4
- Default Configurations 1-4
- Accessories Supplied 1-5
- Accessories Available 1-5

**2 The System Configuration Menu**

- Getting into the System Configuration Menus 2-4
- Layout of the System Configuration Menus 2-5
- Slot Designators 2-6

**3 Configuring the HP-IB and RS-232C**

- Configuring the HP-IB Interface 3-4
- Configuring the RS-232C Interface 3-5
- Configuring the Interface for a Controller or Printer 3-8

**4 Connecting a Printer**

- Connecting HP-IB Printers 4-3
- Connecting RS-232C Printers 4-6
- Connecting to Other Hewlett-Packard Printers 4-9
- Printing the Display 4-11

### 5 The Disk Drive Menus

- Accessing the Disk Menus 5-5
- Installing a Flexible Disk 5-6
- Selecting a Disk Operation 5-7
- Loading a File 5-8
- Formatting a Disk 5-10
- Storing Files on a Disk 5-12
- Renaming a File 5-15
- Autobacking a File 5-17
- Purging a File 5-19
- Copying a File 5-20
- Packing a Disk 5-22
- Duplicating a Disk 5-23
- Making a Directory 5-24
- Changing the Directory 5-25
- Creating a System Flexible Disk 5-26

### 6 The System Utilities Menu

- The Touch and Sound Fields 6-4
  - Touch Calibration 6-4
  - Setting the Real-time Clock 6-6
  - Turning the Sound On/Off 6-7
- Display Color Selection 6-8
  - Selecting the Color, Hue, Saturation, and Luminosity Fields 6-10
  - Selecting Colors 6-12
  - Returning to the Default Colors 6-14

## **7 Intermodule Measurements**

- Accessing the Intermodule Menu 7-5
- Configuring a Group Run 7-6
- Configuring Port In/Out 7-8
- The Group Run/Stop Field 7-10
- The Modules List 7-11
- Status Indicators and Time Correlation Bars 7-12
- Adjusting Skew 7-13
- What Are Some Typical Intermodule Measurements? 7-14
- Displaying Multiple Module Data on One Screen 7-18
- Helpful Hints 7-21

## **8 General Characteristics**

- Characteristics 8-2

## **9 Maintaining the HP 16500B**

- Cleaning Requirements 9-2
- Degaussing 9-3
- Service and Calibration 9-3
- The System Test Menu 9-4
- Repackaging for Storage or Shipment 9-5

## **10 Error Messages**

- Disk Error Messages 10-3
- Disk Warning Messages 10-5
- Powerup Self-Test Documentation 10-6
- Fail Codes 10-7
- Critical Errors 10-8
- Non-Critical Errors 10-8



**System Options**

**1 Using the Optional Keyboard and Mouse**

- Moving the Cursor 1-3
- Entering Data into a Menu 1-5
- Using the Keyboard Overlays 1-7
- Defining Time Units 1-9
- Defining Voltage Units 1-9
- Assigning Edge Triggers 1-10
- Closing a Menu 1-10
- Connecting the Keyboard and Mouse 1-11

**2 The Option HP 16501A Expansion Frame**

- Component Details 2-3
- System Configuration 2-4
- System Arming and Triggering 2-4
- Connecting the HP 16501A Expansion Frame 2-7

**Common Module  
Operations**

**1 Labels Assignment**

- Label Assignment Fields 1-3
- Rolling Labels and Pods 1-5

**2 Symbols Assignment**

- Symbols Field 2-3

**3 Installing and Removing Cards**

- General Installation Procedure 3-3
- HP 16532A Installation Considerations 3-7
- HP 16517A/18A Installation Considerations 3-11



---

W hat Is the  
HP 16500B Logic  
Analysis System ?

---

## The HP 16500B

The HP 16500B is the mainframe of the Hewlett-Packard Logic Analysis System. It offers a modular structure for plug-in cards with a wide range of state, timing, oscilloscope, and pattern generator capabilities. This allows you to configure the HP 16500B using only the modules you need in order to perform a desired measurement or set of measurements, while giving you the flexibility to change or update them later.

The Logic Analysis System provides both experienced and first-time users with powerful measurement capabilities. The pop-up menus and color graphics lead you through setups and measurements quickly and easily, without the need to memorize a lot of steps. By touching the appropriate fields or using the cursor of either the optional mouse or keyboard, you can perform functions, configure menus, and move from one menu to another.

With the intermodule capabilities of the Logic Analysis System, you can make interactive measurements between modules. This allows you to configure modules to interact with each other, using the triggering capabilities of one module and the acquisition capabilities of another.

### **System Options**

The HP 16501A is the add-on mainframe for expanding the module capacity of the HP 16500B. When the HP 16501A is connected to the HP 16500B, they function as a single ten-card system which is turned on and controlled by the HP 16500B. The HP 16501A forms a tightly coupled system with the HP 16500B, permitting each of the two mainframes to arm or trigger any module from any other module.

An optional LAN interface is available for direct connection to computers located on an Ethernet local area network (LAN). The LAN interface enables you to upload measurement data for the most comprehensive post-processing needs and easy access to data files.

---

## Key Features

The key features of the HP 16500B are:

- Modular main frame with five card slots.
- 9-inch color monitor.
- Touchscreen with on/off control.
- Battery backed Real-time clock.
- Programmable PORT IN voltage level and edge selection.
- 3.5-inch flexible disk drive with DOS and LIF format support.
- 170 M byte hard disk drive with DOS format support.
- Internal triggering and 2 ns time correlation of acquired data.
- HP-IB and RS-232C interfaces for:
  - Hardcopy output to a printer
  - Controller interface.

---

## Optional Features

The optional features of the HP 16500B:

- HP 16501A Expansion Frame. Increase available card slots to ten when you connect the expansion frame to an HP 16500B.
- Mouse.
- Keyboard.
- Ethernet LAN interface.
- Expandable system memory up to 64 M bytes.

### See Also

"System Options" form for more information on available system software and hardware options.

## User Interfaces

The HP 16500B has four user interface devices: the knob on the front panel, the touchscreen, the optional mouse, and the optional keyboard.

The knob on the front panel is used to move the cursor on certain menus, increment or decrement numeric fields, and to roll the display.

The touchscreen fields can be selected by touch or with the optional mouse or keyboard. To activate a field by touch, press the dark blue field on the display with your finger until the field changes color. Then move your finger away from the screen to activate your selection. You have the option of disabling the touchscreen with the front-panel Touch On/Off button.

### See Also

The "System Options" part formore information on using the optional keyboard and mouse.

### Screen Contrast and Brightness

Screen contrast and brightness are adjusted by turning the two small knobs located beneath the Touch Screen button. The left knob is for brightness and the right knob is for contrast.

---

## Default Configurations

When the instrument is powered up, predetermined values are automatically assigned to the different fields of the menus to configure the instrument for basic measurements. This allows you to make a basic measurement by turning on the instrument, connecting the probes, and touching the Run field. Often, only minor changes are needed formore complex measurements.

### Storing Default Configurations

The default configurations may be stored on a disk for later use or reset by cycling the power. Storing default configurations on a disk is a convenient way to return to the default values without cycling the power. Default values for each module can be stored separately or together in one file.

### See Also

The "Using the Disk Drive Menus" chapter formore information on the Store operation.

---

## Accessories Supplied

The following list of accessories is supplied with the HP 16500B Logic Analysis System. If any accessory is missing, contact your local sales office.

<b>Accessories Supplied</b>	<b>Qty</b>
Training Kit	1
User's Reference Guide	1
Programming Reference Guide	1
Service Guide	1
Setting Up the System Guide	1
RS-232C Loopback Connector	1
Power Cord	1
Disk pouch containing composite software	1
Feeling Comfortable With Logic Analyzers guide	1
Feeling Comfortable with Digitizing Oscilloscopes guide	1
Filler Panels	*

\* Quantity depends on how many modules are ordered with the HP 16500B /16501A

---

## Accessories Available

Other accessories available for the HP 16500B /16501A Logic Analysis System are listed in the *Accessories for HP Logic Analyzers* brochure.





---

The System  
Configuration  
Menu



---

## The System Configuration Menu



The System Configuration menu is the first menu you see after the initial power-up of the instrument. This menu lists the modules and software options that your system is configured with and shows whether there are five card slots (the HP 16500B alone) or ten card slots (the HP 16500B with the optional HP 16501A attached) available. It also shows if either the optional mouse or keyboard is connected. If a mouse is connected, the system configuration menu indicates whether the mouse is connected directly to the HP 16500B or to a keyboard connected to the mainframe. Finally, the system configuration menu gives you access to the configuration of the HP-IB, RS-232C, and optional LAN interfaces.

**Menu Map**

The following menu map illustrates all fields and available options in the System Configuration menu. The menu map will help you get an overview as well as provide you with a quick reference of what the System Configuration menu contains.

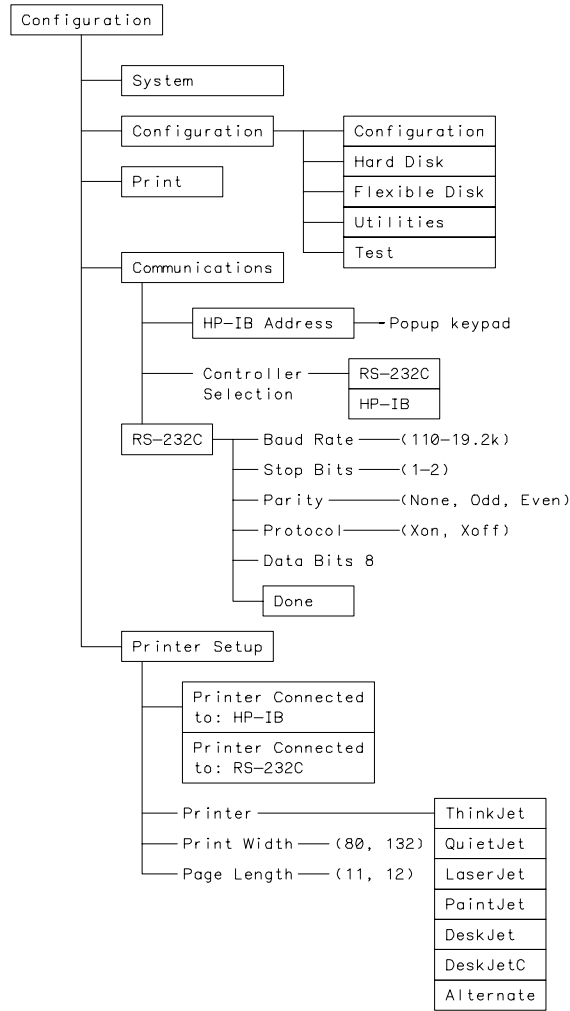

16500B52

**System Configuration Menu Map**

---

## Getting into the System Configuration Menus

In the upper-left corner of the menu are two fields that indicate the current menu and module. The field to the extreme left (System) shows you which module you're in and the one to the right of the module field (Configuration) shows you what menu within the module you've accessed.

To access the System Configuration menu, follow these steps:

1. If the module field in the upper-left corner of the screen does not display "System," select this field and when the pop-up appears, select **System**. This will get you into one of the System menus.
2. If the module field in the upper-left corner of the screen displays "System," but the menu field to the right of System doesn't display "Configuration," select this field. When the pop-up appears, select **Configuration** to display the System Configuration menu.

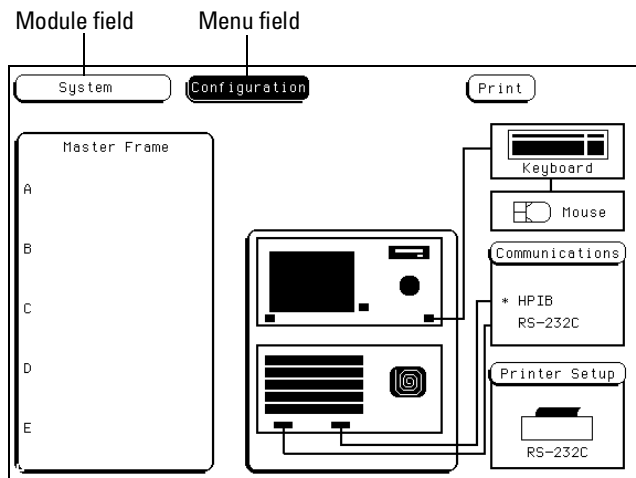

**Module and Menu Fields**

Layout of the System Configuration Menus

The figure below shows the layout of the System Configuration menu for the HP 16500B. The figure is labelled with the major features and functions of the menu.

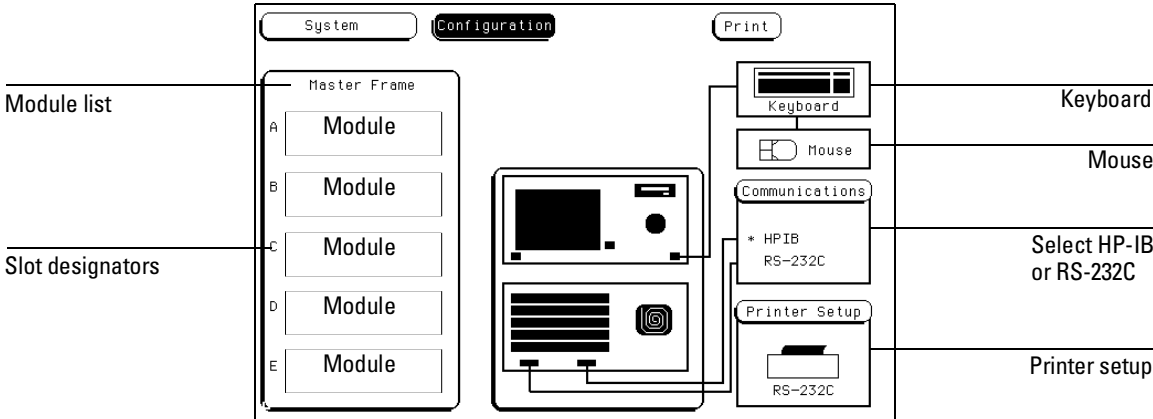

System Configuration Menu

---

## Slot Designators

The slot designators are listed as A through E for the HP 16500B alone, or A through J for the HP 16500B with the HP 16501A attached. The slot designators are displayed to the left of the list of cards for the system and indicate the locations or slots for each card. When you select the Module field, a pop-up appears. The letters after the name of each module indicate the location of each "master" card for that module.

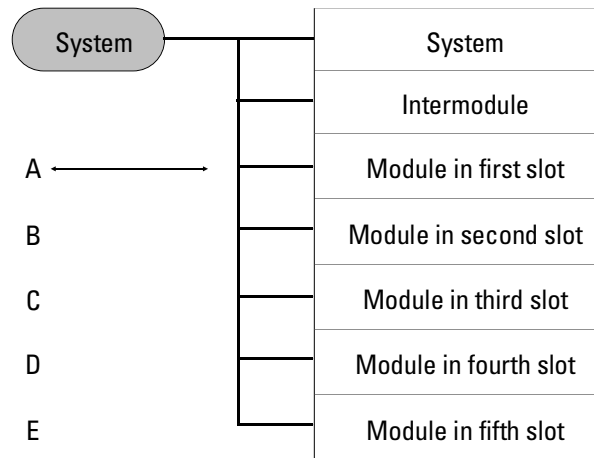

### Slot Designators in Master Frame



---

Configuring the  
HP-IB and RS-232C

---

## The HP-IB and RS-232C Interfaces

This chapter describes the controller and printer interfaces and their configurations. It defines the HP-IB interface and describes how to select any one of the 31 different HP-IB addresses available. It also defines the RS-232C interface and tells you how to select a baud rate, how to change the stop bits, how to set the parity and data bits, and how to change the protocol.

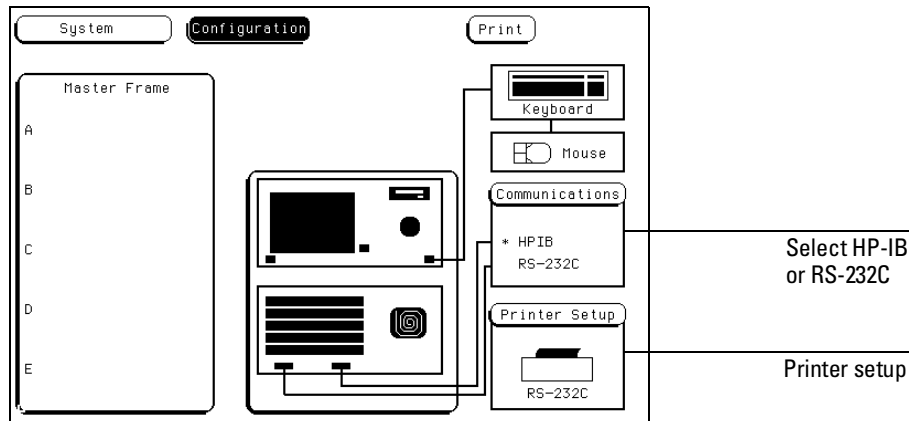

**Controller and Printer Configuration**

### **The Controller Interface**

The HP 16500B is equipped with a standard RS-232C interface and an HP-IB interface that allow you to connect to a controller. This gives you remote access for running measurements, for uploading and downloading configurations and data, for printing, and more. The controller interface is explained in more detail in the *HP 16500B/16501A Programmer's Guide*.

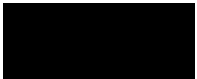

### **The Printer Interface**

The HP 16500B can output its screen display to various HP-IB and RS-232C graphics printers. Configured menus, waveforms, and other data can be printed for complete measurement documentation. The printer interface is explained in more detail in chapter "Connecting a Printer."



---

## Configuring the HP-IB Interface

The Hewlett-Packard Interface Bus (HP-IB) is Hewlett-Packard's implementation of IEEE Standard 488-1978, "Standard Digital Interface for Programmable Instrumentation." The HP-IB is a carefully defined interface that simplifies the integration of various instruments and computers into systems. It uses an addressing technique to ensure that each device on the bus (interconnected by HP-IB cables) receives only the data intended for it. To accomplish this, each device is set to a different address and this address is used to communicate with other devices on the bus.

### Selecting an HP-IB Address

The HP-IB address can be set to 31 different HP-IB addresses, from 0 to 30. Simply choose an address that is compatible with your device or software. The default is 7.

- 1 Select the **Communications** field.
- 2 Using the knob or keypad, enter an HP-IB address in the field directly under "HP-IB Address."

To use the keypad, select the **HP-IB Address** field and a pop-up keypad will appear. Then, enter the address and select **Done**.

- 3 When you are finished configuring the HP-IB Address, select **Done**.

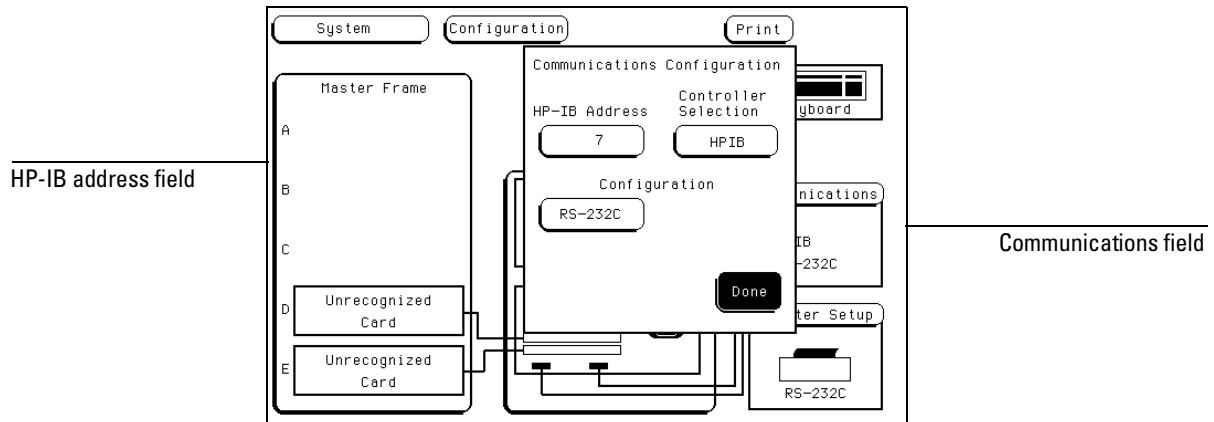

**Communications Configuration pop-up Menu**

## Configuring the RS-232C Interface

The RS-232C interface on this instrument is Hewlett-Packard's implementation of EIA Recommended Standard RS-232C, "Interface Between Data Terminal Equipment and Data Communications Equipment Employing Serial Binary Data Interchange." This interface sends data one bit at a time, and characters are not synchronized with preceding or subsequent data characters. Each character is sent as a complete entity without relationship to other events.

### Baud Rate

The baud rate is the rate at which bits are transferred between the interface and the peripheral. The baud rate must be set to transmit and receive at the same rate as the peripheral, or data cannot be successfully transferred.

1. Select the **Communications** field.
2. Select the **RS-232C** field located directly under the HP-IB Address field.
3. When the pop-up menu appears, select the field directly to the right of "Baud Rate."

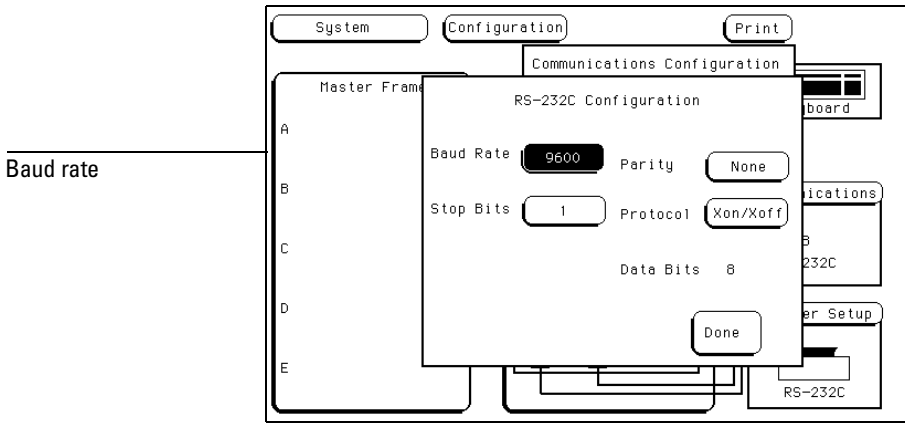

RS-232C Configuration

## Configuring the HP-IB and RS-232C

### Configuring the RS-232C Interface

- 4 When the second pop-up appears, select the baud rate you want from the list displayed in the pop-up (110 to 19 2k) and the pop-up will disappear.

#### Stop Bits

Stop bits are used to identify the end of a character. The number of stop bits must be the same for the controller as for the Logic Analysis System .

- 1 Select the **Communications** field.
- 2 Select the **RS-232C** field located directly under the HP-IB Address field.
- 3 Select the field directly to the right of "Stop Bits" in the RS-232C Configuration pop-up menu.
- 4 When the new pop-up appears, select **1**, **1.5**, or **2** stop bits to identify the end of the character. The pop-up disappears, placing your selection in the appropriate field.

#### Parity

The parity bit detects errors as incoming characters are received. If the parity bit does not match the expected value, the character is assumed to be incorrectly received. The action taken when an error is detected depends on how the interface and the device program are configured.

Parity is determined by the requirements of the system. The parity bit may be included or omitted from each character by enabling or disabling the parity function.

- 1 Select the **Communications** field.
- 2 Select the **RS-232C** field located directly under the HP-IB Address field.
- 3 Select the field directly to the right of "Parity" in the RS-232C Configuration menu.
- 4 When the pop-up appears, select **None**, **Odd**, or **Even** to match the parity of the external device. After you make your selection, the pop-up disappears.

### Protocol

Protocol governs the flow of data between the instrument and the external device.

- 1 Select the **Communications** field.
- 2 Select the **RS-232C** field located directly under the HP-IB Address field.
- 3 Select the field directly to the right of "Protocol" in the RS-232C Configuration pop-up menu.
- 4 When the pop-up appears, select **None** or **Xon/Xoff**.

### None

- With less than a 5-wire interface, selecting None does not allow the sending or receiving device to control how fast the data is being sent. No control over the data flow increases the possibility of missing data or transferring incomplete data.
- With a full 5-wire interface, selecting None allows a hardware handshake to occur. With a hardware handshake, hardware signals control data flow. The HP 13242G cable allows the HP 16500B to support hardware handshake.

### Xon/Xoff

- Xon/Xoff stands for Transmit On/Transmit Off. With this mode, the receiver controls the data flow and can request that the printer stop data flow at any time.
- 5 Select **Done**.

### Data Bits

Data bits are the number of bits sent and received per character that represent the binary code of that character. The HP 16500B supports the 8-bit binary code.

---

## Configuring the Interface for a Controller or Printer

Both the HP-IB and RS-232C interfaces can be configured for either a controller or a printer. You can select the interface and what it controls (printer or controller) in either of two places. When one interface is configured to either the printer or controller, the other interface is automatically switched to the other. One interface is never configured to control both.

- In the Printer Setup menu, toggle the **Printer Connected to:** field.
- In the Communications menu, set the **Controller Selection** field.

For example, one way to configure the RS-232C interface for a printer:

1. Select the **Printer Setup** field, then toggle the **Printer Connected to:** field to **RS-232C**.

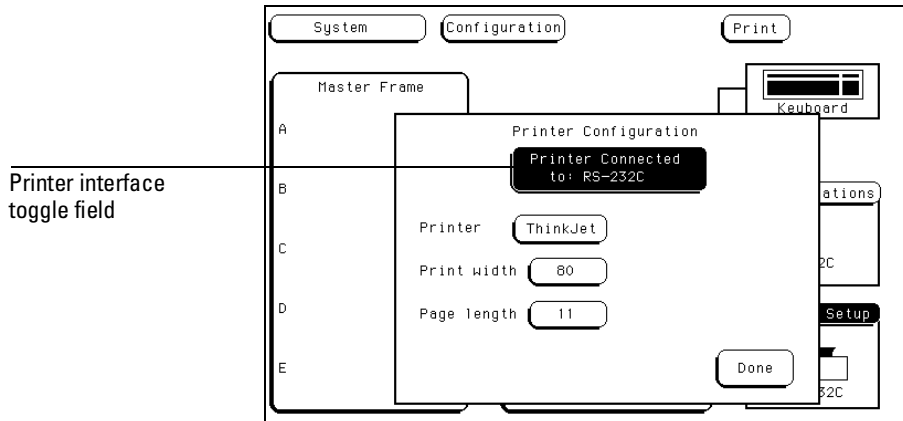

### RS-232C Printer Configuration

Any HP-IB type printer must be set to **Listen Always** for the HP-IB interface. Also, in this mode no HP-IB addressing is necessary.

### See Also

The "Connecting a Printer" chapter for more information on using a printer.



Connecting a  
Printer

---

## Connecting a Printer

The HP 16500B can output its screen display to various HP-IB and RS-232C graphics printers. Configured menus, waveforms, and other data can be printed for complete measurement documentation.

---

## Connecting HP-IB Printers

The HP 16500B interfaces directly with HP PCL printers supporting the printer command language or with Epson printers supporting the Epson standard command set. These printers must also support HP-IB and Listen Always. Printers currently available from Hewlett-Packard with these features include:

- HP ThinkJet.
- HP QuietJet.
- HP LaserJet.
- HP PaintJet.
- HP DeskJet.
- HP DeskJetC

The printer must be in Listen Always when HP-IB is the printer interface. In addition, the HP 16500B HP-IB port does not respond to service requests (SRQ) when controlling a printer. The SRQ enable setting for the HP-IB printer has no effect on HP 16500B printer operation.

### HP-IB Printer Setup

- 1 Turn off the HP 16500B and connect an HP-IB cable from the printer to the HP-IB connector on the rear panel as shown below.

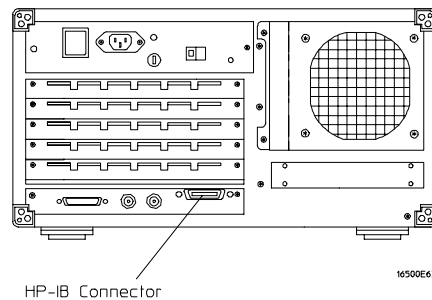

### HP-IB Connector on Rear Panel



## Connecting a Printer

### Connecting HP-IB Printers

- 2 Make sure the printer is in the **Listen Always** (or **Listen Only**) mode.

For example, the figure below shows the configuration switches for an HP-IB ThinkJet printer. For the **Listen Always** mode, move the second switch from the left to the "1" position. Since the HP 16500B doesn't respond to SRQ EN (Service Request Enable), the position of the first switch doesn't matter.

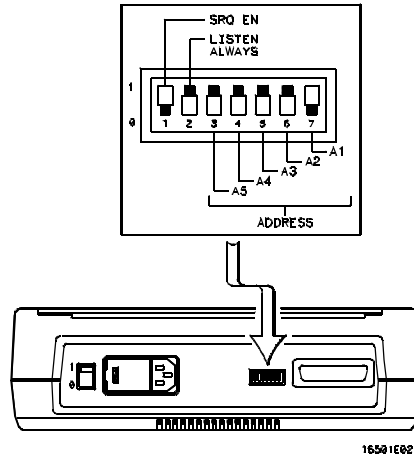

**Configuration Switches for the HP ThinkJet Printer**

#### HP-IB Instrument Setup

- 1 Turn on the HP 16500B. From the System Configuration menu, select the **Printer Setup** field.
- 2 When the Printer Configuration menu appears, toggle the **Printer Connected to:** field to **HP-IB**.
- 3 Select the field to the right of "Printer." When the printer selection pop-up appears, select the printer that you're using (such as ThinkJet, QuietJet). If you're using an Epson graphics printer or an Epson-compatible printer, select **Alternate**.

- 4 Select the field to the right of "Print Width" and depending on your application, toggle the width to either **80** or **132**.  
 Print width tells the printer that you are sending up to 80 or 132 characters per line (when you Print All) and is totally independent of the printer itself.

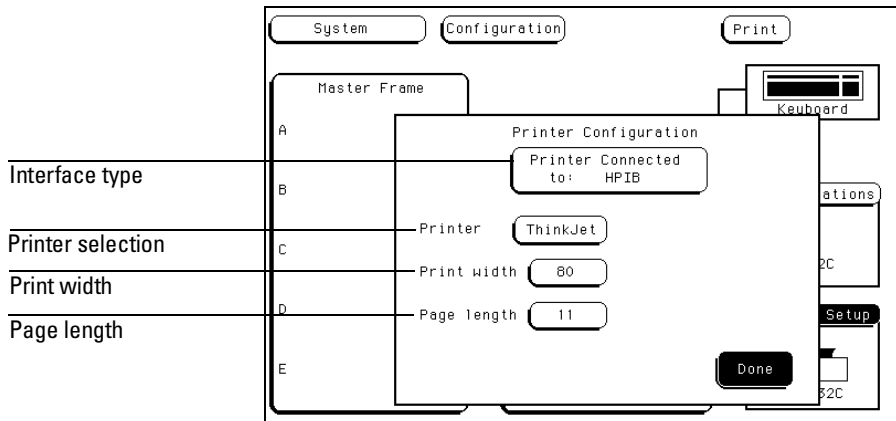

**HP-IB Printer Configuration**

- If you select 132 characters per line when using other than the QuietJet selection, the listings are printed in a compressed mode. Compressed mode uses smaller characters to allow the printer to print more characters within a given area.
  - If you select 132 characters per line for the QuietJet selection it can print a full 132 characters per line without going to compressed mode, but the printer must have wider paper.
  - If you select 80 characters per line for any printer, a maximum of 80 characters are printed per line.
- 5 Select the field to the right of Page Length. Depending on your application, toggle it to either **11** or **12**.  
 Page length tells the printer the page length for the type of paper you are using.
  - 6 Select **Done** when you finished.

## Connecting RS-232C Printers

The HP 16500B interfaces directly with RS-232C printers, including the HP ThinkJet, HP QuietJet, HP LaserJet, HP PaintJet, HP DeskJet and HP DeskJetC printers.

### RS-232C Printer Setup

- 1 Turn off the HP 16500B and connect an RS-232C cable (HP 13242G ) from the printer to the RS-232C connector on the rear panel.

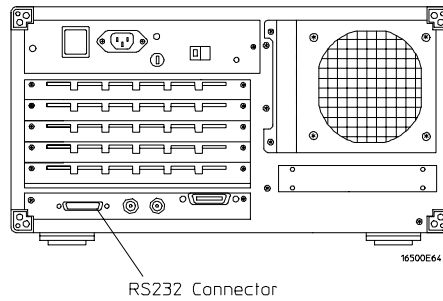

### RS-232C Connector on Rear Panel

2 Before turning on the printer, set the mode switches as follows:

- The HP QuietJet series printers have two banks of mode function switches inside the front cover. Push all the switches down to the "0" position as shown in the figure below.

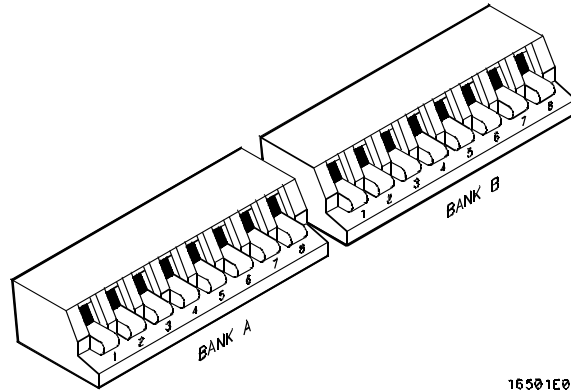

16501E03

**Switch Configuration for HP QuietJet Printers**

- For the HP 2225D (RS-232 HP ThinkJet) printer, the mode switches are on the rear panel of the printer. Push all the switches down to the "0" position as in the figure below.

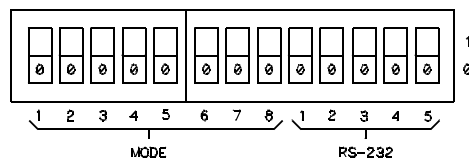

16500E17

**Switch Configuration for HP ThinkJet Printers**

- For the HP LaserJet printer, the switch settings can remain in the factory default settings.

## Connecting a Printer Connecting RS-232C Printers

### RS-232C Instrument Setup

- 1 Turn on the HP 16500B and from the System Configuration menu, select the **Printer Setup** field.
- 2 When the Printer Configuration menu appears, toggle the **Printer Connected to:** field to **RS-232C**.

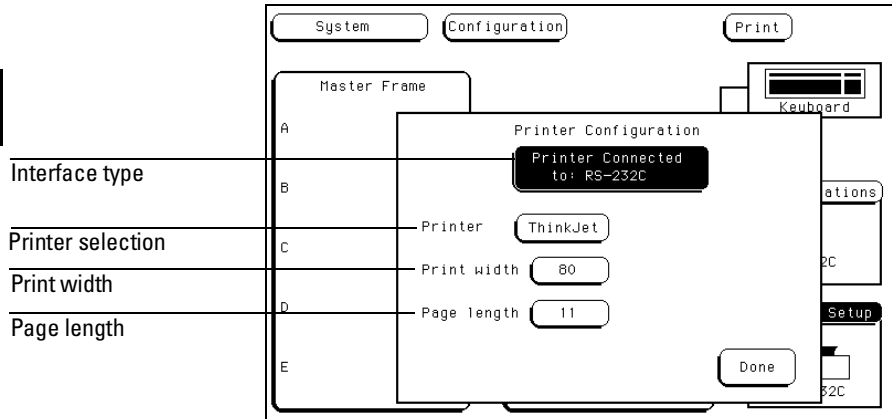

### RS-232C Printer Configuration

- 3 Select the field to the right of "Printer." When the printer selection pop-up appears, select the printer that you're using (such as ThinkJet, QuietJet). If you're using an Epson graphics printer or an Epson-compatible printer, select **Alternate**.
- 4 Select the field to the right of "Print Width." Depending on your application, toggle the width to either **80** or **132**.  
Print width tells the printer that you are sending up to 80 or 132 characters per line (when you Print All) and is totally independent of the printer itself.
- 5 Select the field to the right of "Page Length." Depending on your application, toggle it to either **11** or **12**.  
Page length tells the printer the page length for the type of paper you are using.
- 6 Select **Done** when you finished.

### RS-232C Interface Setup

- 1 From the System Configuration menu, select the **Communications** field.
- 2 From the Communications Configuration menu that appears, select the **RS-232C** field just to the right of the HP-IB Address field.
- 3 From the RS-232C Configuration menu that appears, set the baud rate, stop bits, parity, and protocol depending on your application.

For complete information on these RS-232C interface parameters go to "What is the RS-232C Interface" section in the HP-IB and RS-232C chapter found earlier in this manual.

---

## Connecting to Other Hewlett-Packard Printers

The HP 16500B can also be used with other Hewlett-Packard graphics printers. Simply connect the printer to the HP 16500B using the appropriate cable (HP-IB or RS-232C) and configure the HP 16500B as shown in the following table.

---

### HP Printer Selection

---

For this HP Printer	Select this Printer from the pop-up
HP 2631G	QuietJet
HP 2671G	ThinkJet
HP 2673A	ThinkJet
HP 9876A	ThinkJet
HP 2932/34 (option 046)	QuietJet

## Connecting a Printer

### Connecting to Other Hewlett-Packard Printers

HP-IB printers must support Listen Always to work with the HP 16500B. The HP 82906A graphics printer is not supported because it does not support Listen Always on HP-IB.

The HP 2932A or HP 2934A option 046 printer is configured from the front panel of the printer, instead of with switches on the rear panel. The correct configuration for the HP 16500A is shown in the figure below.

#### See Also

Refer to the *HP 16500B Programming Manual* for information on setting up an external controller to activate the printer.

```
***** SETTINGS *****
***** LIST *****
PRINTER INTERFACE PRINTER INTERFACE
***** LIST INTERFACE *****
HP-IB
SECONDARY COMMANDS LISTEN ALWAYS SERVICE REQUEST ADDRESS SET DEFAULTS
off on off 1
***** END OF SETTINGS *****
```

16501B01

#### Configuration for the HP 2932/34 Option 046

---

## Printing the Display

Each menu has a **Print** field in the upper-right corner. Select the **Print** field and a pop-up appears, displaying your choices. Depending on the measurement module and menu you are printing, only some of the following choices will appear.

- **Cancel** stops the print.
- **Print Screen** prints everything shown on the screen.
- **Print All** prints all of the information listed for that display, including any listings that do not appear on screen. These listings can be 80 or 132 characters wide, depending on the print width setting.
- **Print Partial** prints a partial range.
- **Print Line** prints lines between a designated start and end line.
- **Print Record** prints records between a designated start and end record.
- **Print Disk** prints everything shown on a single screen, or all data from the listing buffer, to either the flexible or hard disk.

### Configuring a Print to Disk

When you select the **Print Disk** option, a **Print to Disk** configuration menu appears as shown below.

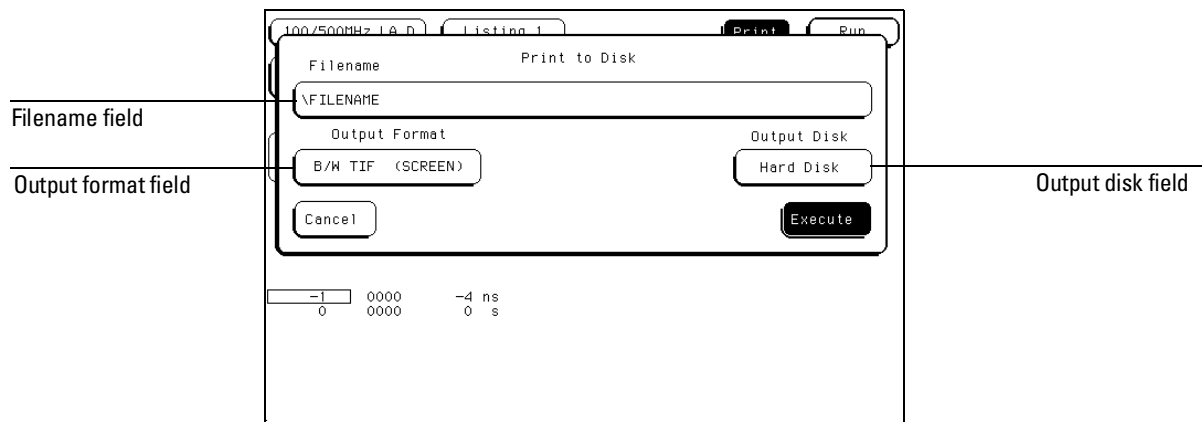

**Print to Disk Menu**



## Connecting a Printer

### Printing the Display

- 1 Select the **Filename** field, then enter a filename (LIF), or the path and filename (DOS).

If the file is stored to a DOS disk, the filename can contain up to 8 characters plus a 3 character extension. If the file is stored on a LIF disk, up to 10 characters can be used for the filename and no extension is required. The filename plus any path may contain up to 64 characters.

- 2 Select the **Output Format** field, then select one of the following formats:

**ASCII (All)** All data in listing buffer in ASCII format.

**BW TIF (Screen)** The current screen in black and white with TIF format.

**Color TIF (Screen)** The current screen in color with TIF format.

**PCX (Screen)** The current screen in color with PCX format.

When storing to DOS disk, if you forget to add the extension, it will be added automatically according to the format type.

- 3 Select the **Output Disk** field, then select the destination disk.



The Disk Drive  
Menus

---

## Using the Disk Drive Menus

The logic analysis system has both a 3.5 inch, double-sided, high-density or double-density, flexible disk drive and an 85 M byte hard disk drive built in. The flexible disk drive is compatible with both LIF (Logical Interchange Format) and DOS (Disk Operating System) formats. The hard disk drive is formatted for a DOS file system.

This chapter describes the disk operations available in both the hard disk and flexible disk menus, and how to use them. It is organized into separate "How to" examples demonstrating the use of the Disk menus and all the disk operations.

### The Disk Operations

- Autoload

Designates a set of configuration files to be loaded automatically the next time the analyzer is turned on.

- Copy

Any file can be copied from one disk to another or to the same disk.

- Duplicate Disk

All volume labels, directories, and file positions from one disk are copied exactly to another disk. The new disk is formatted to match the source disk if it is required. All files on the destination disk will be destroyed with this operation.

- Format Disk

The hard disk, and any double-sided, double-density, or high-density, 3.5-inch flexible disk can be formatted in either LIF or DOS format. The directory and all files on the disk will be destroyed with this operation.

- Load

Instrument system configurations, analyzer measurement setups, including measurement data, and inverse assembler files for the analyzer can be loaded from the disk drive.

- Pack Disk

This function packs files on a LIF disk. Packing removes all empty or unused sectors between files on a disk so that more space is available for files at the end of the disk.

- Purge

Any file on a disk can be purged (deleted) from the disk.

- Rename

Any filename on a disk can be changed to another name.

- Store

Instrument system configurations and analyzer measurement setups including measurement data can be stored to either disk drive.

- Change Directory

The present working directory (PWD) can be changed to any other directory on either the hard disk or flexible disk drives.

- Make Directory

New directories can be created on both the hard disk and flexible disk.

### Disk Operation Safeguards

If there is a problem or additional information is needed to execute an operation, an advisory will appear displaying an error message or a prompt for more information. If executing any disk operation could destroy or damage a file, a warning appears before you select Execute.

### Disk Operations using the Optional LAN

Performing disk operations using the optional LAN interface is restricted to DOS formatted disks. For more information refer to the *LAN Interface Module User's Guide*.

### Menu Map

The following menu map illustrates all fields and available options in the Disk Drive menu. The menu map will help you get an overview as well as provide you with a quick reference of what the Disk Drive menu contains.

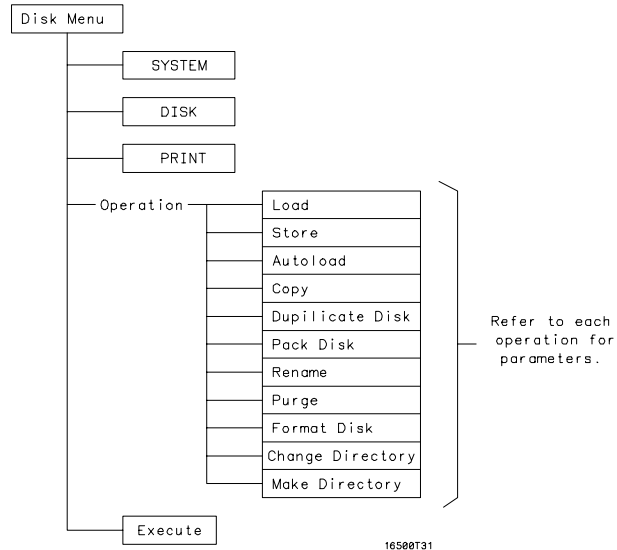

### Disk Drive Menu Map

---

Accessing the Disk Menus

- 1 Select the **Module** field.
- 2 From the pop-up menu that appears, select **System**.
- 3 Select the **Menu** field.
- 4 From the pop-up that appears, select either the **Flexible disk** or **Hard disk** field.

The directory of each disk is automatically read and displayed as each disk menu is accessed.

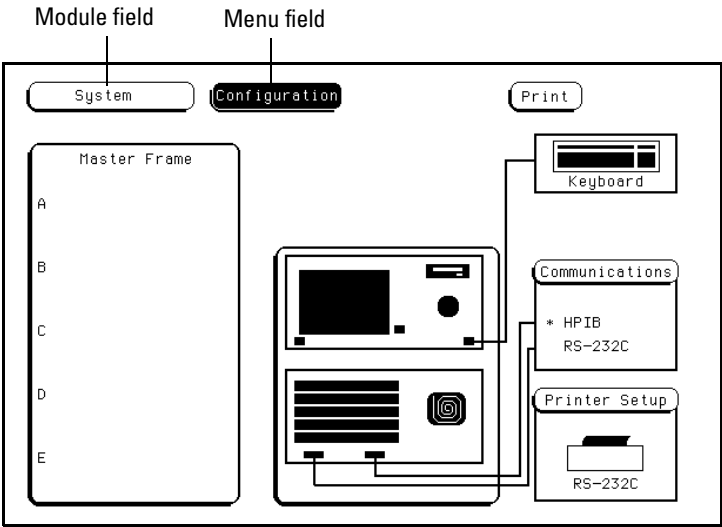

**Menu Name Field**

### Installing a Flexible Disk

- 1 Hold the disk so the disk label is on top and the metal auto-shutter is away from you.
- 2 Push the disk gently, but firmly, into the disk drive until it clicks into place.

You can use double-sided, double-density and double-sided, high-density disks. To display all files on any disk, insert the disk into the drive, then turn the knob.

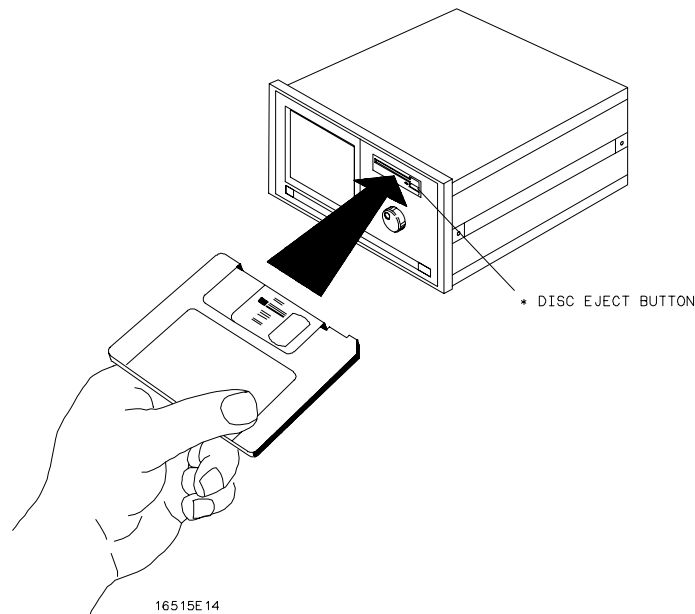

### Installing a Disk

---

## Selecting a Disk Operation

Although some default parameters are provided, a disk operation may require new information from the user. This information is entered in the appropriate parameter fields within each disk operation menu.

1. Select the **Disk Operation** field.
2. From the pop-up menu that appears, select the desired disk operation.

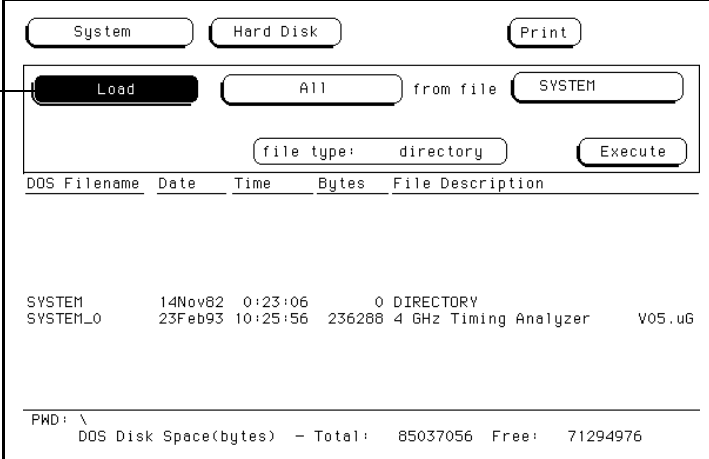
Disk operation field — 

DOS Filename	Date	Time	Bytes	File Description
SYSTEM	14Nov82	0:23:06	0	DIRECTORY
SYSTEM_0	23Feb93	10:25:56	236288	4 GHz Timing Analyzer V05.u6

PWD: \  
DOS Disk Space(bytes) - Total: 85037056 Free: 71294976

### Disk Operation Field

When performing disk operations, the path and disk capacity information located at the bottom of the menu will be helpful.

### DOS Formats

**PWD:** is the present working directory from which the files are contained.

**Total:** is the total memory capacity (bytes) of the flexible or hard disk.

**Free:** is the total memory capacity (bytes) remaining.

### LIF Formats

**Total:** is the total memory capacity (blocks) of the flexible disk.

**Free:** is the total memory capacity (blocks) remaining.

**Largest:** is the size of the largest block remaining.



---

## Loading a File

The Load operation allows you to load prestored configuration files. Use this operation when you want to quickly restore the analyzer to a configuration used in a previous measurement or condition.

- 1 Insert the source disk into the disk drive.
- 2 Select the **Load** operation.

When the Load selection is made, the analyzer reads the disk directory and displays a list of all files on the disk.

- 3 Select the **File type** field.

The screenshot shows a menu interface with several buttons: 'System', 'Flexible Disk', and 'Print' at the top. Below them are 'Load' and 'All' buttons, followed by 'from file' and a field containing 'SYS\_004'. A 'file type:' field contains '004@16500B' and an 'Execute' button is to its right. A table with columns 'DOS Filename', 'Date', 'Time', 'Bytes', and 'File Description' lists two files: 'SYSTEM' and 'SYS\_004'. At the bottom, a 'DOS Disk Space(bytes)' section shows 'Total: 1474560' and 'Free: 231424'. A label 'File type field' with a line points to the 'file type:' field.

DOS Filename	Date	Time	Bytes	File Description
SYSTEM	13Apr93	0:59:58	812032	HP16500B System Software V01.ae
SYS_004	13Apr93	1:02:26	413952	4 GHz Timing/1 GHz State V01.qe

PWD: \  
DOS Disk Space(bytes) - Total: 1474560 Free: 231424

### File Type Parameter Field

- 4 From the pop-up that appears, select the desired file type.  
The **System** choice loads things like interface (RS-232C HP-IB) and intermodule configurations, and defaults from the Utilities menu.  
The **Module** choice loads measurement module configurations and data.  
The **All** choice loads both System and module configurations and data files.
- 5 Select the desired file name from the list by rotating the knob. As the knob is rotated, the file names are rolled into the Filename field.  
The two spaces( ) after the filename designates that this file is for the system. One space and a letter (for example, "\_A") after the filename designates that the file is for the measurement module in slot A.

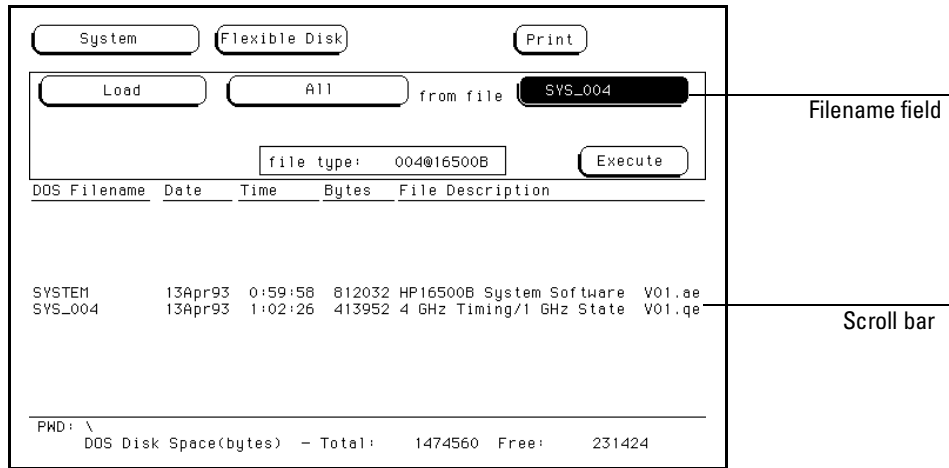

### Filename Selection

- 7 Select the **Execute** field.  
The disk drive indicator light illuminates as the file is being loaded.

---

## Form atting a Disk

The Form at operation initializes new flexible disks for use in the analyzer as well as reform ats the hard drive. The analyzer will form at double-sided, double density or high density flexible disks in both LIF and DOS form ats. The analyzer does not support single-sided form ats.

The logic analyzer does not support track sparing during form atting. If a bad track is found, the disk is considered bad. If a disk has been form atted elsewhere with track sparing, it will be read successfully.

To form at a flexible disk, perform the following steps:

1. Insert the flexible disk to form at into the disk drive.
2. Select the **Format Disk** operation.

When the Form at selection is made, the disk directory is displayed. The UNSUPPORTED FORMAT message appears if the disk is a new unform atted disk. This is normal, continue the form at operation.

3. Select the **Format type** field, and toggle to either the **LIF** or **DOS**.

The analyzer recognizes a variety of sector sizes for LIF disks. However, when form atting LIF disks, the analyzer only creates 1024 byte sectors. When form atting DOS disks, the analyzer creates 512 byte sectors.

LIF Filename	Date	Time	Blocks	File Description
AUTOLOAD	24Feb93	14:59:45	1	status: ENABLED file: YYJJLOAD_?
SYSTEM_001	24Apr92	10:06:29	200	1 GHz Timing Analyzer V05.01
SYSTEM_032	24Apr92	10:06:21	1696	100MHz State/500MHz Time V05.01
YYJJLOAD_B			268	status: ENABLED file: BOOT_?

LIF Disk Space(blocks) - Total: 3060 Free: 895 Largest: 778

Format type field

### LIF or DOS Format Selection

---

**CAUTION**

---

**BEFORE YOU CONTINUE**, be sure you are in the **FLEXIBLE DISK** menu. Since you can format both the flexible and hard disks, you always should be sure as to which disk menu you are in.

---

**CAUTION**

---

Once the format operation is executed, all files are permanently erased from the disk being formatted. This includes the **HARD DISK**. There is no way to retrieve the original information from a formatted disk.

- 4 Select the **Execute** field, then select **Continue**.

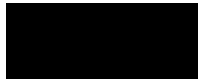

---

## Storing Files on a Disk

The Store operation allows you to store instrument configurations and measurement data. Use this operation when you want to save the present analyzer setup for recalling at a later time. When configurations are stored to disk, you are given the option to store System only, module only, or All (System and module).

- 1 If you are storing to a flexible disk, insert the destination disk into the flexible disk drive.
- 2 Select the **Store** operation.

When the Store selection is made, the analyzer reads the disk directory and displays a list of all files on the disk.

- 3 Select the **File type** field.

File type field

The screenshot shows a graphical user interface for the 'File type field'. At the top, there are three buttons: 'System', 'Flexible Disk', and 'Print'. Below these is a 'Store' button, which is highlighted. To the right of 'Store' is a dropdown menu set to 'All', followed by 'to file' and a text field containing 'SYSTEM\_001'. Below this is a 'file description' field containing '1 GHz Timing Analyzer V05.01' and a 'file type' field containing '001@16500A'. An 'Execute' button is located to the right of the 'file type' field. Below the form is a table with columns: LIF Filename, Date, Time, Blocks, and File Description. The table contains four rows of data. At the bottom of the form, there is a summary line: 'LIF Disk Space(blocks) - Total: 3060 Free: 895 Largest: 778'.

LIF Filename	Date	Time	Blocks	File Description
AUTOLoad	24Feb93	14:59:45	1	status: ENABLED file: YYJLOAD_?
SYSTEM_001	24Apr92	10:06:29	200	1 GHz Timing Analyzer V05.01
SYSTEM_032	24Apr92	10:06:21	1696	100MHz State/500MHz Time V05.01
YYJLOAD_B			268	status: ENABLED file: BOOT_?

LIF Disk Space(blocks) - Total: 3060 Free: 895 Largest: 778

### File Type Parameter Field

- 4 From the pop-up that appears, select the desired file type.

The **System** choice loads interface (RS-232C and HP-IB) and instrument configurations, and defaults from the Utilities menu.

The **Module** choice loads measurement module configurations and data.

The **All** choice loads both System and module configurations and data files.

- 5 If you are storing to a new name, select the "to file" field and type in the new name.

The filename must start with a letter and may contain up to eight characters. It can be any combination of letters and numbers, but there can be no blank spaces between any of the characters.

If you are storing to an existing filename, simply turn the knob to scroll existing filenames through the field.

LIF Filename	Date	Time	Blocks	File Description
AUToload	24Feb93	14:59:45	1	status: ENABLED file: YYJJLOAD_?
SYSTEM_001	24Apr92	10:06:29	200	1 GHz Timing Analyzer V05.01
SYSTEM_032	24Apr92	10:06:21	1696	100MHz State/500MHz Time V05.01
YYJJLOAD_B			268	status: ENABLED file: BOOT_?

LIF Disk Space(blocks) - Total: 3060 Free: 895 Largest: 778

to file: field

### File Name Field

When performing disk operations, the path and disk capacity information located at the bottom of the menu will be helpful.

### DOS Formats

**PWD:** is the present working directory from which the files are contained.

**Total:** is the total memory capacity (bytes) of the flexible or hard disk.

**Free:** is the total memory capacity (bytes) remaining.

### LIF Formats

**Total:** is the total memory capacity (blocks) of the flexible disk.

**Free:** is the total memory capacity (blocks) remaining.

**Largest:** is the size of the largest block remaining.

## The Disk Drive Menu Storing Files on a Disk

- 6 Select the "file description" field and using the pop-up keypad, type in a description of the file.

A file description can contain up to 32 characters, but also can be left blank. This field is for your convenience to make it easier for identifying the type of data in each file.

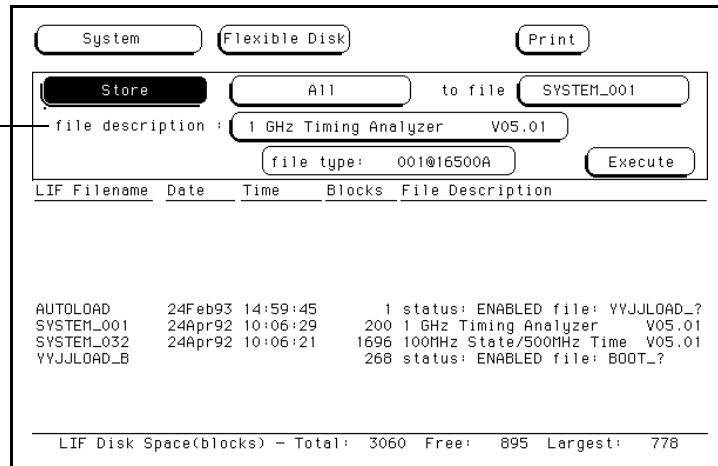

The screenshot shows a menu with buttons for 'System', 'Flexible Disk', and 'Print'. The 'Store' button is highlighted. Below it, there are fields for 'All' and 'to file SYSTEM\_001'. The 'file description' field contains '1 GHz Timing Analyzer V05.01'. Below this is a 'file type' field with '001@16500A' and an 'Execute' button. A table lists files with columns for LIF, Filename, Date, Time, Blocks, and File Description. At the bottom, it shows disk space statistics: LIF Disk Space(blocks) - Total: 3060, Free: 895, Largest: 778.

LIF	Filename	Date	Time	Blocks	File Description
AUTOLOAD		24Feb93	14:59:45	1	status: ENABLED file: YYJJLOAD_?
SYSTEM_001		24Apr92	10:06:29	200	1 GHz Timing Analyzer V05.01
SYSTEM_032		24Apr92	10:06:21	1696	100MHz State/500MHz Time V05.01
YYJJLOAD_B				268	status: ENABLED file: BOOT_?

LIF Disk Space(blocks) - Total: 3060 Free: 895 Largest: 778

File description:  
field

### File Description Field

---

## Renaming a File

The Rename operation allows you to give a new name to a previously stored file. The only restriction is that you cannot rename a file to an already existing filename.

- 1 Select the **Rename** operation.
- 2 Turn the knob until the file name you want to rename is scrolled into the file field.

File field

System Hard Disk Print

Rename file SYSTEM\_0 type 004@16500A

to file type: 004@16500A Execute

DOS Filename	Date	Time	Bytes	File Description
SYSTEM	14Nov82	0:23:06	0	DIRECTORY
SYSTEM_0	23Feb93	10:25:56	236288	4 GHz Timing Analyzer V05.uG

PHD: \  
DOS Disk Space(bytes) - Total: 85037056 Free: 71094272

Type field

### File Field

- 3 Select the file **Type** field. From the pop-up that appears, select the desired type selection.
- The **All** selection allows you to rename both the system and module types. The **Module** selection allows only the module file type to be renamed.



# The Disk Drive Menus

## Renaming a File

4 Select the new file name field.

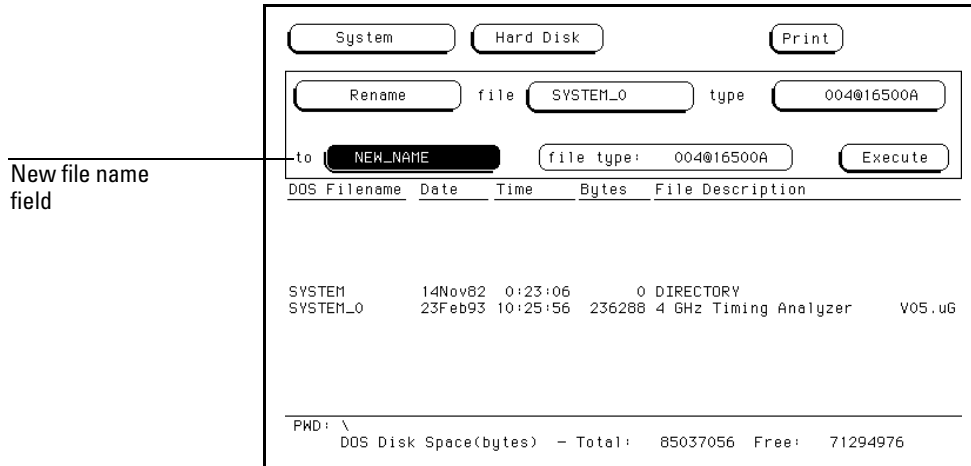

New file name field

System Hard Disk Print

Rename file SYSTEM\_0 type 004@16500A

to NEW\_NAME file type: 004@16500A Execute

DOS Filename	Date	Time	Bytes	File Description
SYSTEM	14Nov82	0:23:06	0	DIRECTORY
SYSTEM_0	23Feb93	10:25:56	236288	4 GHz Timing Analyzer V05.u6

PWD: \  
DOS Disk Space(bytes) - Total: 85037056 Free: 71294976

### New File name Field

5 Using the pop-up keypad, type in the new filename, then select **Done**.

---

## Autoloading a File

The Autoload operation allows you to designate a set of configuration files to be loaded automatically the next time the instrument is turned on. This allows you to change the default configuration of certain menus to a configuration that better fits your needs.

- 1 Select the **Autoload** operation.
- 2 Select the **Enable/Disable** field then select **Enable**.
- 3 Turn the knob until the file name you want to autoload is scrolled into the file name parameter field.

Enable/Disable field

System	Hard Disk	Print		
<b>Autoload</b>	Disable			
Current AUTOLOAD status : DISABLED				
Current AUTOLOAD file :				
file type: 004@16500A		Execute		
DOS Filename	Date	Time	Bytes	File Description
SYSTEM	14Nov82	0:23:06	0	DIRECTORY
SYSTEM_0	23Feb93	10:25:56	236288	4 GHz Timing Analyzer V05.uG
PND: \				
DOS Disk Space(bytes) - Total: 85037056 Free: 71094272				

### Autoload File name Parameter Field

## The Disk Drive Menus Autoloading a File

### 4 Select the **Execute** field.

An autobad file is created and placed at the top of the list of files. The file description contains the file name to be autobaded and indicates whether or not the Autobad operation is enabled.

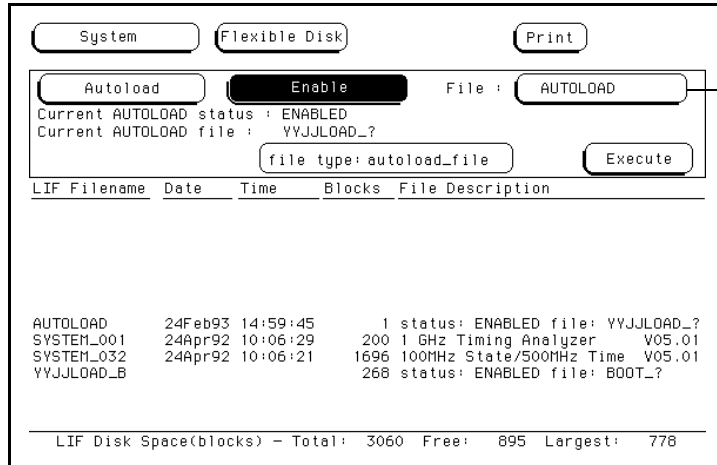

System Flexible Disk Print

Autoload Enable File : AUTOLOAD

Current AUTOLOAD status : ENABLED  
Current AUTOLOAD file : YYJJLOAD\_?

file type: autoload\_file Execute

LIF Filename	Date	Time	Blocks	File Description
AUTOLOAD	24Feb93	14:59:45	1	status: ENABLED file: YYJJLOAD_?
SYSTEM_001	24Apr92	10:06:29	200	1 GHz Timing Analyzer V05.01
SYSTEM_032	24Apr92	10:06:21	1696	100MHz State/500MHz Time V05.01
YYJJLOAD_B			268	status: ENABLED file: BOOT_?

LIF Disk Space(blocks) - Total: 3060 Free: 895 Largest: 778

File name  
parameter field

### Autoload File name Field

The Autobad operation autobads all files for a given file name. If you want to load only the file for a type, rename that file to separate it from the other files and enable it as the current Autobad file.

As long as Autobad is enabled before the instrument is shut off, Autobad will remain enabled when you power up the instrument and load the configuration files.

---

## Purging a File

The Purge operation allows you to delete a file from the list of file names. The file type can be either the Module type or All type.

- 1 Select the **Purge** operation.
- 2 Turn the knob to scroll the file name to be purged into the "file" field.

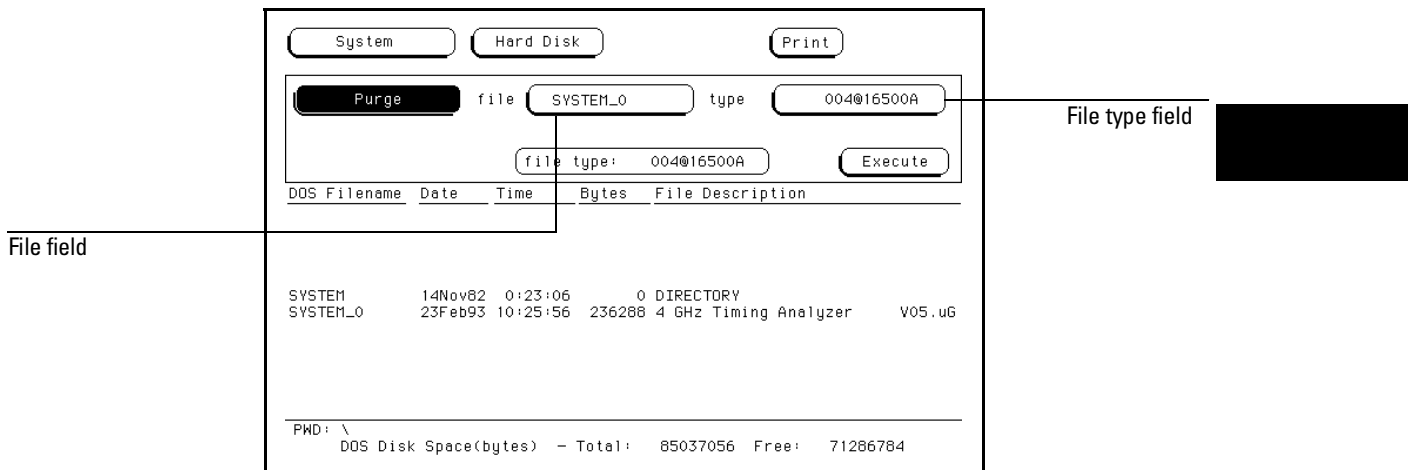

### File Field

- 3 Select the file "type" field, then select the file type to purge.  
The **All** selection allows you to purge both the system and module types.  
The **Module** selection allows only the analyzer type to be purged.
- 4 Select the **Execute** field, then select **Continue**.

---

## Copying a File

The Copy operation allows you to make a duplicate copy of an existing file on the same disk or a different disk. If you copy the file to the same disk, the only restriction is that you must give the copied file a new name. You can specify to copy **All** types or just the **Module** part of a file.

1. Select the **Copy** operation.
2. Turn the knob until the file name you want to copy is scrolled into the "file" field.

File field

Type field

DOS Filename	Date	Time	Bytes	File Description
SYSTEM	14Nov82	0:23:06	0	DIRECTORY
SYSTEM_0	23Feb93	10:25:56	236288	4 GHz Timing Analyzer V05.u6

PWD: \  
DOS Disk Space(bytes) - Total: 85037056 Free: 71094272

### Copy Filename Parameter Field

3. Select the "type" field, then select the desired file type.

The **All** selection allows you to copy both the system and module parts of a configuration file set.

The **Module** selection allows only the module part to be copied.

- 4 Select the new file name field, then from the pop-up keypad that appears, enter the new file name in one of two ways:
  - If you want to keep the old name, simply select **CLEAR**, then the **DONE** field from the keypad. The old name is transferred automatically.
  - If you want a new name, type in the new name, then select **DONE**.

New file name field

System Hard Disk Print

Copy file SYSTEM\_0 type 004@16500A to

NEW\_FILE\_NAME

on Flexible Disk file type: 004@16500A Execute

DOS Filename	Date	Time	Bytes	File Description
SYSTEM	14Nov82	0:23:06	0	DIRECTORY
SYSTEM_0	23Feb93	10:25:56	236288	4 GHz Timing Analyzer V05.u6

PHD: \  
DOS Disk Space(bytes) - Total: 85037056 Free: 71286784

#### New filename Field

- 5 Select the **Execute** field.

---

## Packing a Disk

By purging files from the disk and adding other files, you may end up with blank areas on the disk (between files) that are too small for the new files you are creating. On LIF disks, the Pack Disk operation packs the current files together, removing unused areas from between the files so that more space is available for files at the end of the disk.

1. Select the **Pack Disk** operation.
2. Select the **Execute** field, then select **Continue**.

System Hard Disk Print

**Pack Disk**

file type: directory Execute

DOS Filename	Date	Time	Bytes	File Description
SYSTEM	14Nov82	0:23:06	0	DIRECTORY
SYSTEM_0	23Feb93	10:25:56	236288	4 GHz Timing Analyzer V05.UG

PWD: \  
DOS Disk Space(bytes) - Total: 85037056 Free: 71286784

Execute field

### Pack Disk Operation

## Duplicating a Disk

The Duplicate Disk operation copies the volume labels and directories from one disk to another. If the new disk is not formatted, this operation also formats the disk. This operation allows you to make a backup copy of your important disks so you won't lose important data in the event that a disk wears out, is damaged, or a file is accidentally deleted.

- 1 Select the **Duplicate Disk** operation.
- 2 Select the **Execute** field, then select **Continue**.

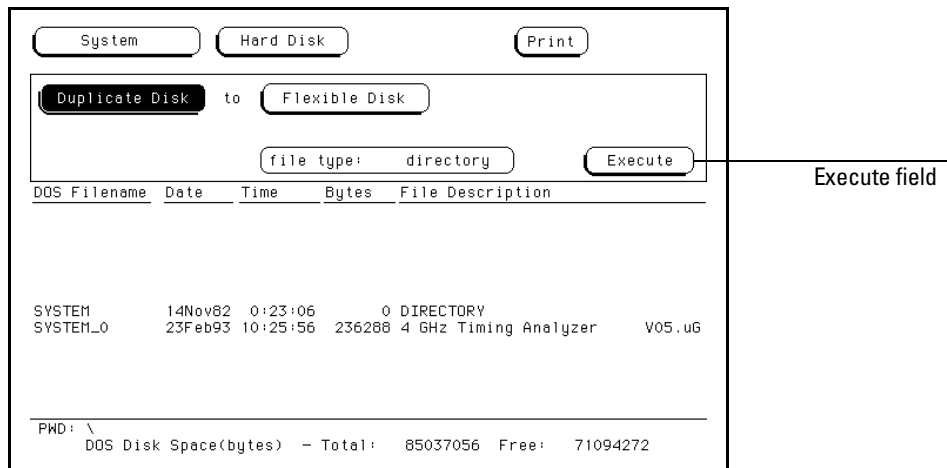

### The Duplicate Disk Operation

- 3 When "Insert DESTINATION disk" appears, insert the destination disk into the disk drive. When "Insert SOURCE disk" appears, remove the destination disk and reinstall the source disk. The number of times you need to change the disks depends on whether you have a double-density or high-density disk. Simply follow the instructions and select Continue to continue.

### CAUTION

The original directory and files on the destination disk are destroyed by the **Duplicate Disk** operation.



### M a k i n g a D i r e c t o r y

- 1 Select the **Make Directory** operation.
- 2 Select the directory name field and using the pop-up keypad or keyboard, type in the new directory name.
- 3 Select **Execute**, then select **Continue**.

DOS Filename	Date	Time	Bytes	File Description
SYSTEM	14Nov82	0:23:06	0	DIRECTORY
SYSTEM_0	23Feb93	10:25:56	236288	4 GHz Timing Analyzer V05.u6

PMD: \  
DOS Disk Space(bytes) - Total: 85037056 Free: 71286784

### **Make Directory**

---

## Changing the Directory

- 1 Select the **Change Directory** operation.
- 2 Select the directory name field. Using the pop-up keypad or keyboard, type in the new directory name.
- 3 Select **Execute**.

DOS Filename	Date	Time	Bytes	File Description
SYSTEM	14Nov82	0:23:06	0	DIRECTORY
SYSTEM_0	23Feb93	10:25:56	236288	4 GHz Timing Analyzer V05.u6

PWD: \  
DOS Disk Space(bytes) - Total: 85037056 Free: 71286784

### Change Directory

When performing disk operations, the path and disk capacity information located at the bottom of the menu will be helpful.

### DOS Formats

**PWD:** is the present working directory from which the files are contained.

**Total:** is the total memory capacity (bytes) of the flexible or hard disk.

**Free:** is the total memory capacity (bytes) remaining.

### LIF Formats

**Total:** is the total memory capacity (blocks) of the flexible disk.

**Free:** is the total memory capacity (blocks) remaining.

**Largest:** is the size of the largest block remaining.

## Creating a System Flexible Disk

### Location of the System Files

When the logic analysis system is configured at Hewlett-Packard with the appropriate modules, the system files for the mainframe and individual modules were loaded onto the hard disk drive in the subdirectory called "SYSTEM". It is recommended that if new modules are added or any system file revisions occur, they be loaded onto the hard disk drive in this subdirectory.

However, if you want system files on a flexible disk, use the appropriate disk operations, such as store or copy, to store all required system files on a flexible disk.

### What Files are Required on a System Disk?

A system disk consists of the software required to operate the mainframe and each module in the system. For the mainframe, this is the file SYSTEM\_ of the file type 16500B\_system. For the individual modules, it is the file SYS\_XXX of the file type XXXXXX\_system. The three characters (XXX) in the filename represent the identification code for each individual module. The six characters (XXXXXX) in the file type represent the product model number for each module.

### What is a system performance verification disk?

A system performance verification disk is a disk that contains all the performance verification software required to run the performance verification tests for the HP 16500B Logic Analysis System and the corresponding modules configured in the system. This composite disk is found in each software pouch. For more information on the performance verification tests, refer to the *HP 16500B Service Guide*.

All system performance verification files are stored on the hard disk in the /SYSTEM subdirectory.



The System  
U tilities M enu

---

## The System Utilities Menu

The System Utilities menu is one of the menus within the System module. The menu is used for turning the sound on and off, recalibrating the touchscreen, setting the clock, and changing the default instrument colors.

### Accessing the System Utilities Menu

In the upper-left corner of the screen are two fields that indicate which module, and which menu within that module you are in.

If the Module field in the upper-left corner doesn't display System, select this field and when the pop-up appears, select **System**. This will bring up one of the System menus.

Once in the System module, if the Menu field doesn't display Utilities, select this field. When the pop-up appears, select **Utilities** to bring up the System Utilities menu.

Layout of the System Utilities Menu:

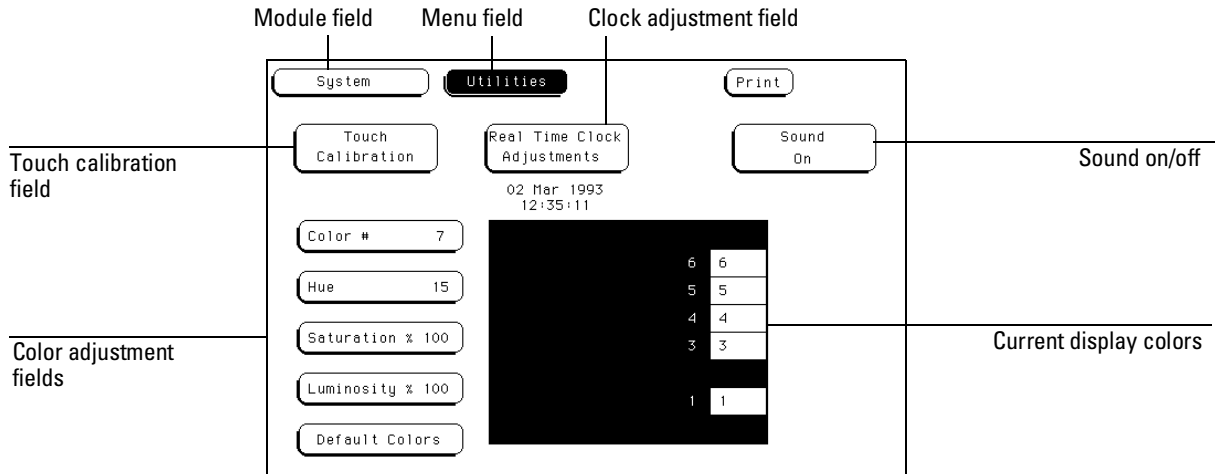

### The System Utilities Menu

**Menu Map**

The following menu map illustrates all fields and available options in the Utilities menu. The menu map will help you get an overview as well as provide you with a quick reference of what the Utilities menu contains.

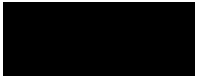
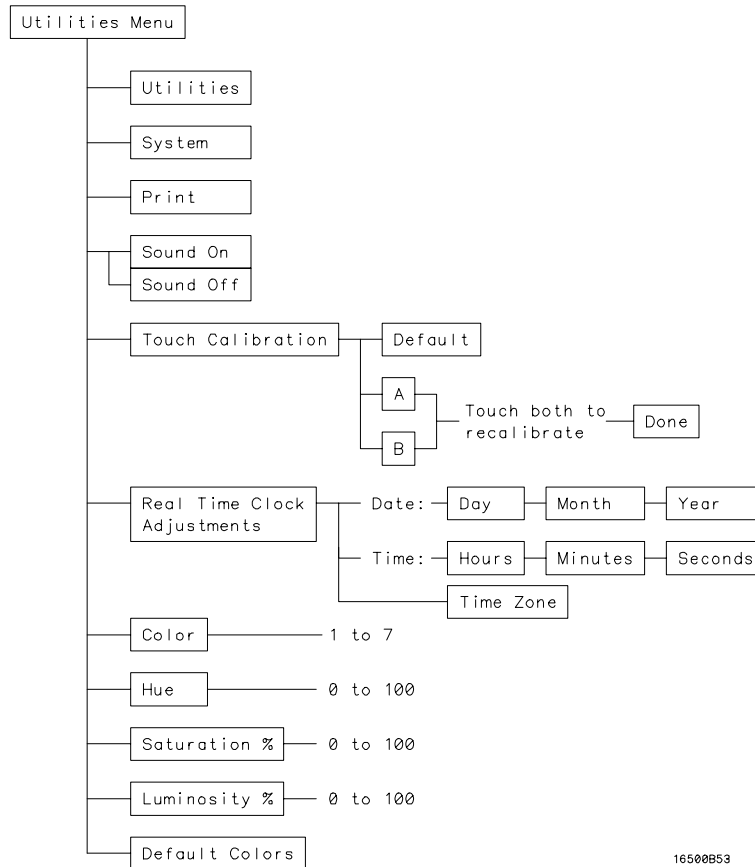

**System Utilities Menu Map**

16500B53

---

## The Touch and Sound Fields

This section covers the Touch and Sound fields of the System Utilities menu. These fields allow you to recalibrate the touchscreen for better line-of-sight use and turn on and off the sound of the instrument.

---

### Touch Calibration

It is unnecessary to periodically calibrate the touchscreen. Touch calibration just allows you to reset the touchscreen to your needs and compensate for parallax from different viewing angles.

The Touch Calibration field in the upper-left corner of the display brings up the pop-up for adjusting the touchscreen calibration to your own line of sight and to the angle at which you touch the screen.

Touch Calibration field

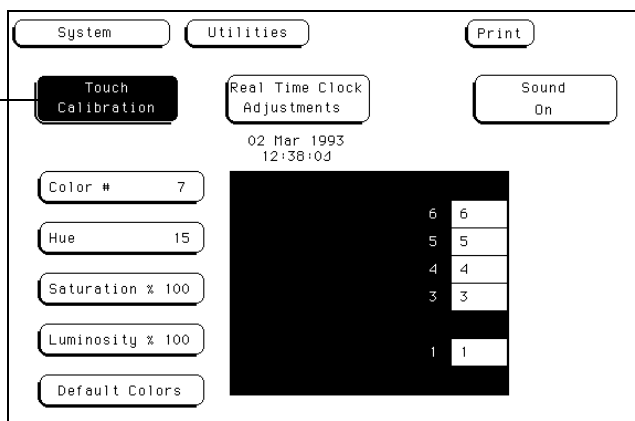

### Selecting Touch Calibration

The default calibration is acceptable for most uses, but to change the calibration do the following:

1. Select the **Touch Calibration** field.
2. Select the **A** field as accurately as possible.
3. Select the **B** field as accurately as possible.

Recalibration is done immediately after you touch A or B. The point at which you remove your finger from A or B determines where you place your finger to activate subsequent fields.

4. Select **Done** when you are finished.

To return to the default Touch calibration, select the **Touch Calibration** field and when the pop-up appears, select the **Default** field. This returns the instrument to its default touchscreen calibration. Select **Done** when you are finished.

At power-up, touch returns to the default calibration, unless a customized HP 16500B configuration file is loaded as part of an autoboot sequence.

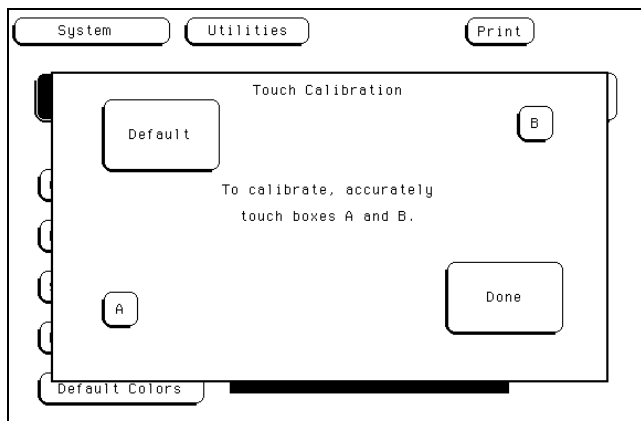

**Touch Calibration Pop-up**

#### **Touch On/Off**

To turn the Touch function off, press the **Touch Disable** button on the front panel.



## Setting the Real-time Clock

For documentation purposes, a real-time clock readout appears in the display menus. To adjust the real-time clock, simply select the **Real Time Clock Adjustments** field, then select the date or time element desired from the pop-up menu shown below. Use the knob to set numbers and the keyboard or touchscreen to select the correct month. When you are finished, select **Done**.

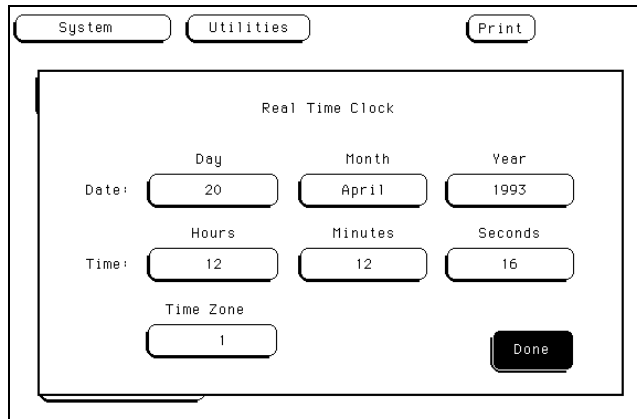

The image shows a pop-up menu titled "Real Time Clock" with a "Done" button. The menu is divided into sections for "Date" and "Time". The "Date" section has three fields: "Day" (20), "Month" (April), and "Year" (1993). The "Time" section has three fields: "Hours" (12), "Minutes" (12), and "Seconds" (16). Below the "Time" section is a "Time Zone" field with the value "1". The menu is framed by a border with "System", "Utilities", and "Print" buttons at the top.

Field	Value
Date: Day	20
Date: Month	April
Date: Year	1993
Time: Hours	12
Time: Minutes	12
Time: Seconds	16
Time Zone	1

**Real-time Clock Pop-up**

---

## Turning the Sound On/Off

In the upper-right corner, below the Print field, is the Sound On field. This field is used to turn the instrument's sound on and off. These include the clicks you hear when you select fields on the menus and the beeps you hear on error messages.

To turn off the sound, select **Sound On** and it changes to **Sound Off**, shutting off the sound. To turn them on again, select **Sound Off** and it changes back to **Sound On**, turning the sound on again.

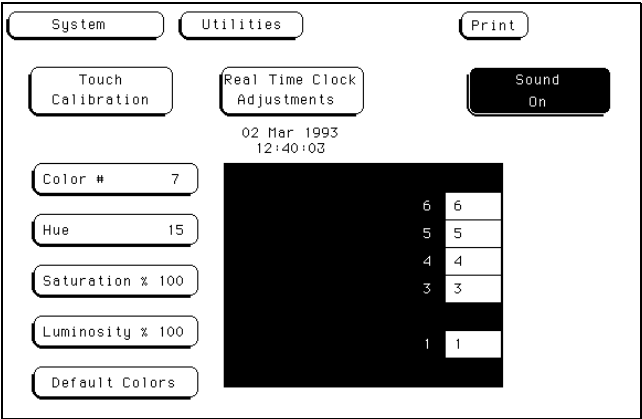

**The Sound On Field**

In the HP 16500B, color saves time and prevents errors by clarifying the display, making it easier to distinguish one major area from another.

The color selection feature of the HP 16500B allows you to customize display colors, which improves contrast and lessens eye fatigue caused by your operating environment. If you are color-blind to certain colors, are operating in a difficult light environment, or don't like the default colors, you can quickly and easily change them.

### The Color Model

The HP 16500B uses the HSL color model (Hue, Saturation, and Luminosity). This model is very effective for interactive color selection. Similar in concept to the method used by artists for mixing paints, pure hues are selected, and then white and black are mixed to dilute the color or darken it.

- Hue is the pure color. 0 is red, 33 green, and 67 blue. The selection ranges from 0 to 100.
- Saturation is the ratio of the pure color mixed with white (0 to 100%).
- Luminosity is the brightness per unit area (0 to 100%).

The figure on the next page shows a cylindrical representation of the HSL model (Hue, Saturation, and Luminosity). Hue is the angular coordinate, Saturation is the radial coordinate, and Luminosity is the altitude above the polar coordinate plane.

The cylinder rests on a black plane (Luminosity = 0%) and extends upward. As you increase in altitude, you increase luminosity, which represents an increase in brightness. Whenever luminosity is zero, the values of saturation and hue do not matter. Zero luminosity is black, and 100% luminosity gives you the pure color.

White is the center of the top of the cylinder (Luminosity = 100% , Saturation = 0% ). The center line of the cylinder (Saturation = 0% ) is a line which connects the center of the black plane (Luminosity = 0% , Saturation = 0% ) with white (Luminosity = 100% , Saturation = 0% ) through a series of gray steps (Luminosity from 0% to 100% , Saturation = 0% ). Whenever saturation is 0% , the value of hue does not matter. Zero saturation is white , and 100% saturation gives you the pure color. The outer edge of the cylinder (Saturation = 100% ) represents the fully saturated color.

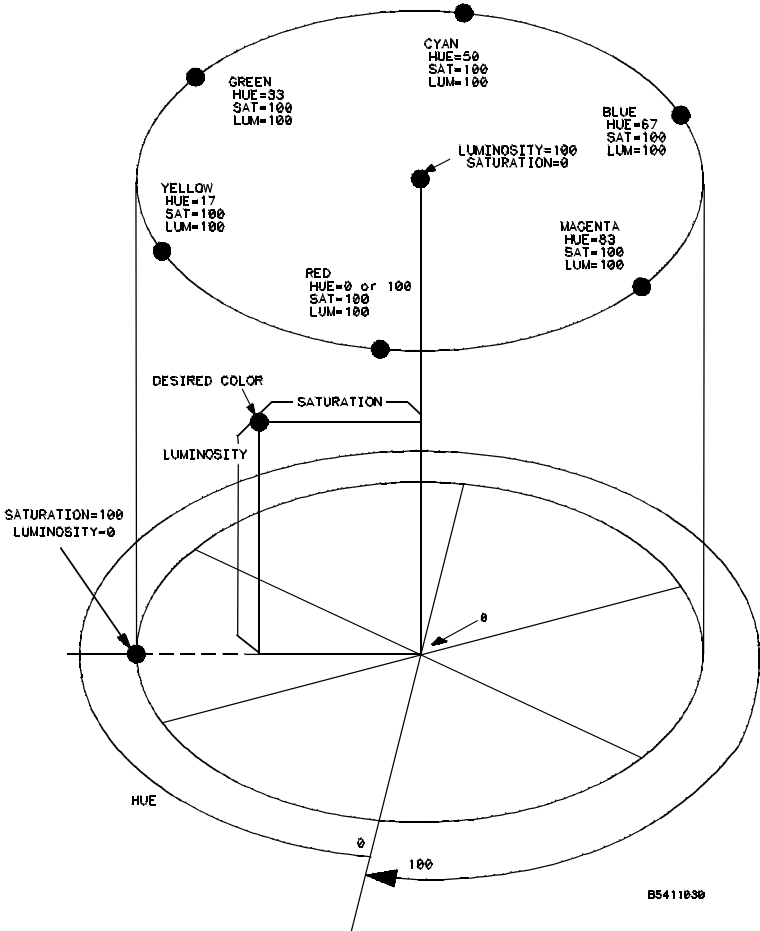

**The Color Model**

---

## Selecting the Color, Hue, Saturation, and Luminosity Fields

To select the Color, Hue, Saturation, or Luminosity fields, see if the field you want has a different background than the other fields (light blue for the default colors). If it already has a different background, rotate the knob to change the value in that field. Otherwise, select the field once and its background will change color, indicating that it has been selected. Then rotate the knob to change the value. If you look at the large field in the center of the display, you can see how the knob affects the color.

If you know the value you want in a particular field, see if that field has a different background than the other fields (light blue for the default colors). If it already has a different background, select this field and a pop-up keypad will appear. Otherwise, select the field once to select it and a second time to bring up the pop-up keypad. Then enter the value you want with the keypad and select Done. The pop-up will disappear, placing your new value in the appropriate field and changing the color.

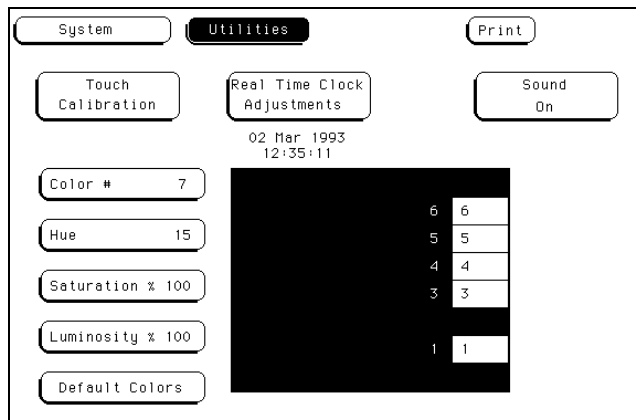

### Color Selection

---

**Example**

Use the knob to change the value of Hue to 45.

- 1 Select the **Hue** field once.
- 2 When the background of the **Hue** field changes color (light blue for default colors), turn the knob to change the value for **Hue** to 45. You can see how the knob affects the color in the large field at the center of the display.

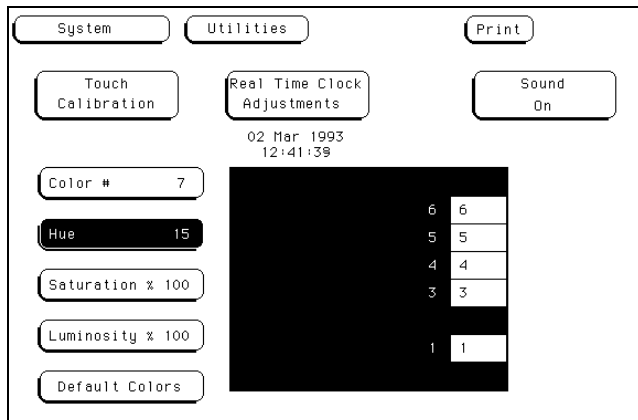

**Changing the Value for Hue**

## The System Utilities Menu Selecting Colors

---

### Example

Use the pop-up keypad to change the value of Luminosity to 65.

- 1 Select the **Luminosity** field once and its background changes color (light blue for default colors).
- 2 Select the **Luminosity** field a second time and a pop-up keypad appears.
- 3 Enter 65 with the keypad and notice that your value appears in the box at the top of the keypad.
- 4 When you are finished, select **Done** and the pop-up keypad will disappear, placing your value in the appropriate field and changing the color.

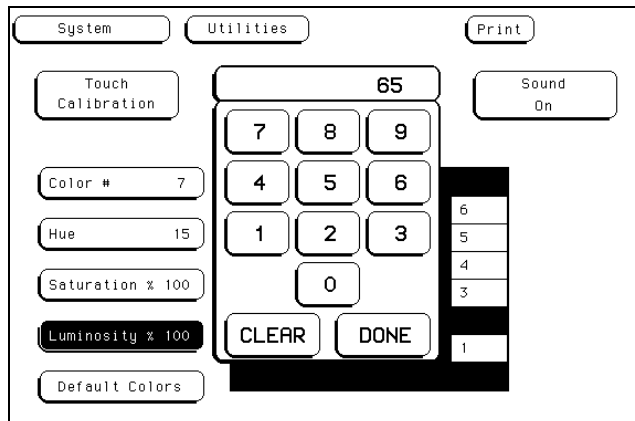

### Changing the Value for Luminosity

---

## Selecting Colors

Once the Color field has been selected, you can select any one of seven variable display colors by rotating the knob on the front panel. The Color field displays your choice (1 through 7). The large field to the right of the Color field displays the color you are working with, and the small numbered fields within this large field display the other colors available. The table on the next page lists the display colors for the HP 16500B.

The screen may be turned off when using an external controller by setting the Luminosity of each color to zero.

---

---

**HP 16500B Display Colors**

---

Color	Default Color	Hue	Saturation	Luminosity	Uses
1	Tan	13	43%	76%	Main background color for the display
2	White	0	0%	100%	Light text and timing waveforms on certain modules
3	Dark Blue	60	100%	60%	For touch items (touch-sensitive fields)
4	Light Blue	60	45%	90%	For selected items, items that the knob is assigned to, limited background use, and certain display channels on the oscilloscope module
5	Green	33	100%	75%	For the Run field, advisory fields, the X marker on certain modules, certain display channels for the oscilloscope module, and miscellaneous other uses
6	Red	0	100%	100	For the Stop field, error fields, the Cancel Print field, the trigger point, and certain display channels on the oscilloscope module
7	Yellow	15	100%	100%	For warning or advisory fields, the O marker on certain modules, certain display channels on the oscilloscope module, and miscellaneous other uses
0*	Black	—	—	0%	For dark text, background, and waveform areas

\* Color "0" is a non-variable color.



## Returning to the Default Colors

The Default Colors field, below the Luminosity field, allows you to return to the default colors simply by selecting that field. These default colors are listed in the table on the previous page.





Interm odule  
M easurem ents

---

## Intermodule Measurements

The HP 16500B can be configured with several different modules inside the instrument at one time. The Intermodule menu allows you to make interactive measurements between these modules. As an example, you would use the acquisition capabilities of one module to look at a signal, while using the triggering capabilities of another module to properly trigger the measurement.

When modules are configured in the Intermodule menu, you also have the capability to display the resulting waveforms and state listings from several modules together in the same display menu.

The basic functions of the Intermodule menu are:

- Configure modules to run simultaneously or in an arming sequence between modules.
- Synchronize with external equipment.
- Adjust skew between modules.

### Configuring Arming Sequences

You select modules to run either independently or within an intermodule configuration. As you make module selections, a configuration tree begins to form. In addition, an arming order forms dependent on the order in which you select the modules.

Within the configuration tree, modules that are connected directly to the large **Group Run** field are armed immediately after a **Group Run** is executed. Modules that appear connected below other modules are armed when the preceding module finds its trigger.

### Synchronizing with External Equipment

Once a module is added to the configuration tree, the PORT OUT signal can be added beneath that module or any other module, which sends an arming signal out to a BNC connector on the rear panel.

The PORT IN signal can be selected to arm the intermodule configuration in conjunction with the Group Run/Stop field. You can qualify the PORT IN signal by defining level and edge criteria.

### Adjusting Skew between Modules

You can modify the skew or timing deviation between the modules within the intermodule measurement. This allows you to compensate for any known delay of the system under test or compare two signals by removing any displayed skew between the signals.

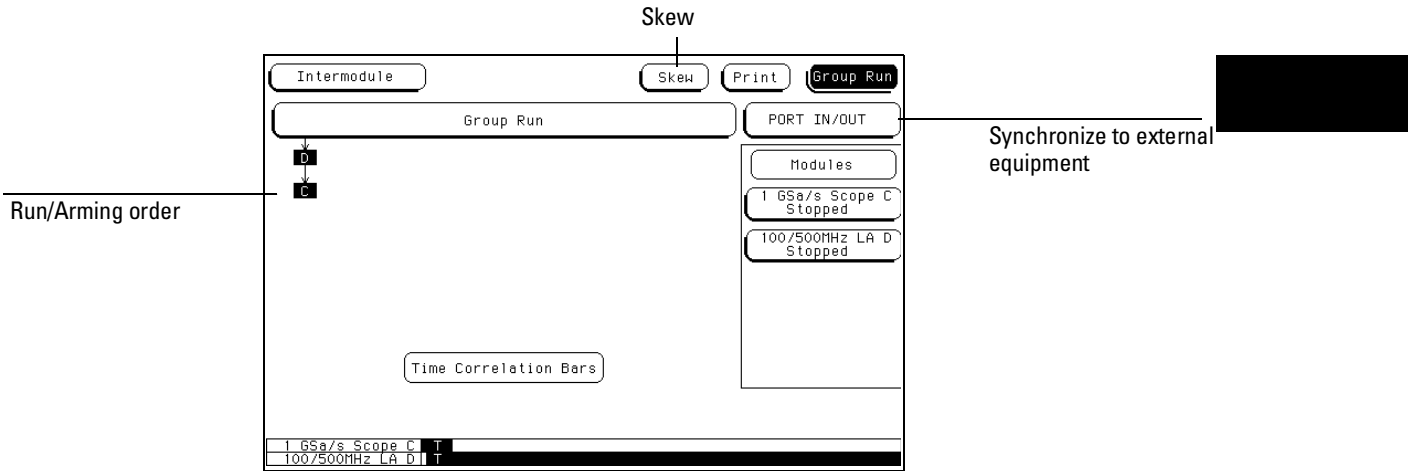

The Intermodule Menu

**Menu Map**

The following menu map illustrates all fields and available options in the Intermodule menu. The menu map will help you get an overview as well as provide you with a quick reference of what the Intermodule menu contains.

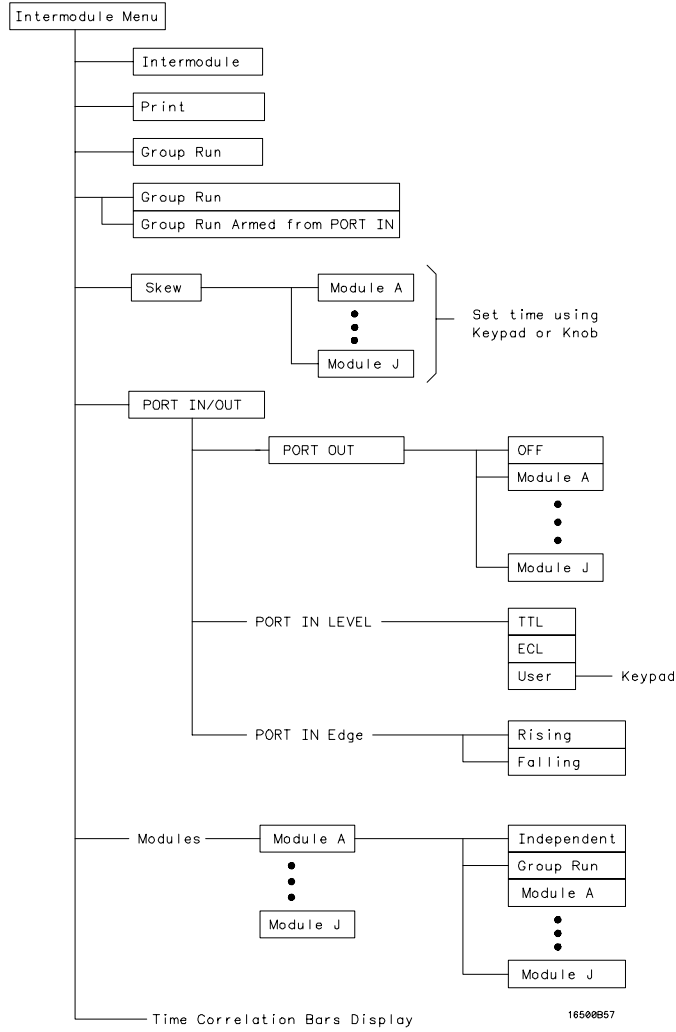

**Intermodule Menu Map**

---

## Accessing the Intermodule Menu

To bring up the Intermodule menu, select the module field in the upper-left corner of any menu. When the selection pop-up appears, select the **Intermodule** field to bring up the Intermodule menu.

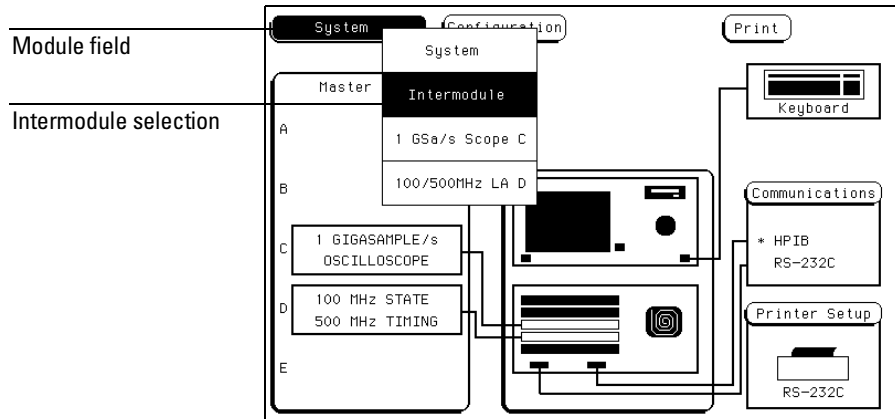

### Accessing the Intermodule Menu

With only one measurement module loaded into the system, intermodule measurements are not possible, so, the Intermodule menu is not available. If you have an HP 16501A Expansion Frame connected, modules loaded into the expansion frame are available for an intermodule measurement.

---

## Configuring a Group Run

When the **Group Run** field is selected, it toggles between two choices which sets how the intermodule measurement is armed.

**Group Run** This selection starts the intermodule measurement when you select the Group Run field in any of the module menus. This field is also the Run field, but when you have an intermodule measurement configured, the Run field changes to Group Run. You still have the choice to run the group in Single or Repetitive acquisition mode.

### Group Run Armed from PORT IN

This selection starts the intermodule measurement when an external trigger source, matching the trigger level and edge requirements you set, is seen at the PORT IN BNC connector on the rear panel.

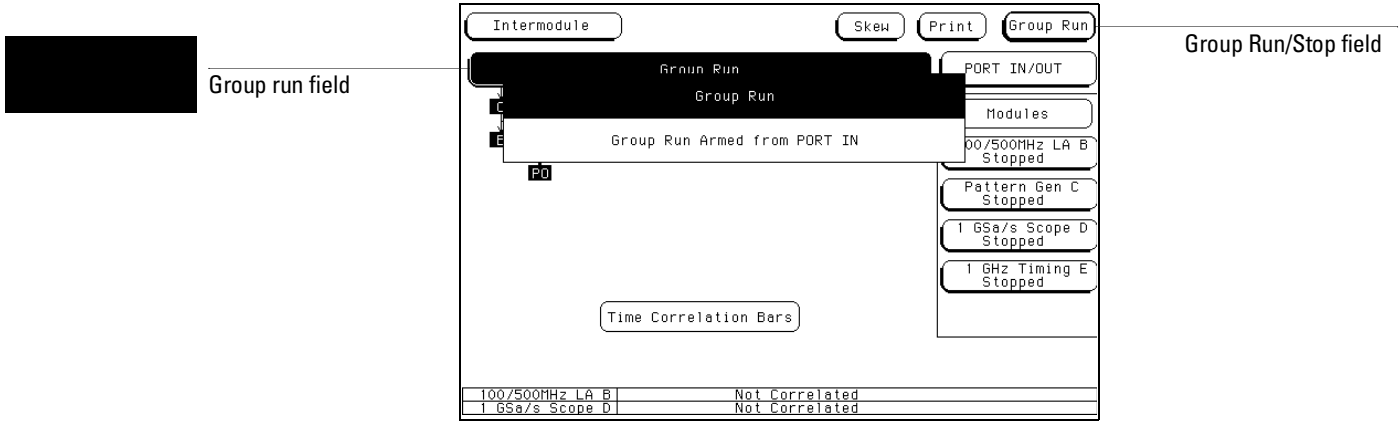

### Group Run Field

**Example**

The following example illustrates what happens when you execute a Group Run. For this example we use the intermodule configuration shown in the figure below.

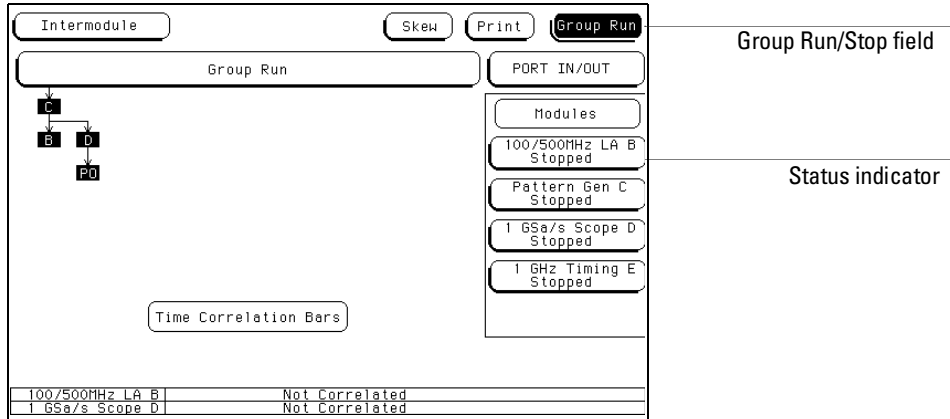

When you select the **Group Run** field, the following events occur:

- 1 The status indicator of each module involved changes from **Stopped** to **Running**.
- 2 The prestore and trigger qualification status of module B (analyzer) and module D (oscilloscope) is checked.
- 3 When prestore and trigger qualification of modules B and D are met, module C is armed and its appropriate measurement is run.
- 4 Module C triggers, and simultaneously arms modules B and D.
- 5 Module D triggers, and sends a signal to an external device through "PO" (PORT OUT).
- 6 The status of each module changes to **Stopped** when the module finishes its operations. After all the modules are finished, the data is displayed in the individual display menus of the modules.

If the modules are time correlated, the time correlation bars at the bottom of the menu display the start and stop acquisition window of each module relative to the other modules.



---

## Configuring Port In/Out

The PORT IN/OUT field accesses a configuration menu which is used to configure which module an external timing signal (PORT OUT) is sent from. Also, from this menu you define voltage level and edge criteria that must be matched by any incoming timing signal (PORT IN) before the intermodule measurement can begin. The PORT IN/OUT field is shown below.

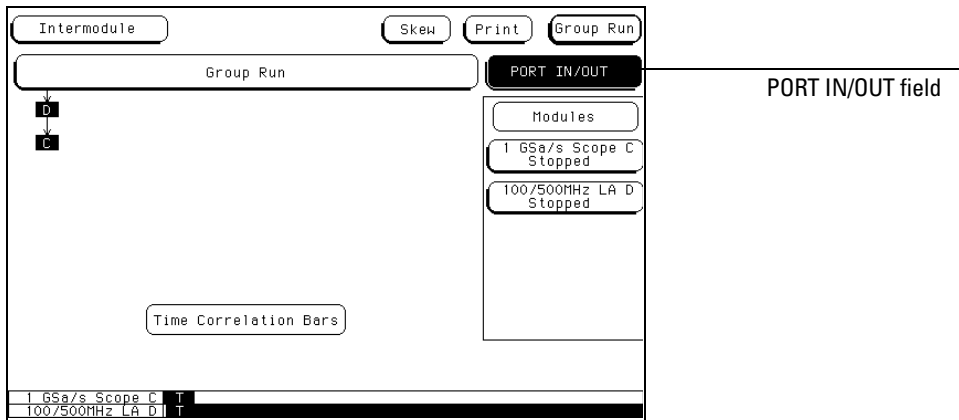

### PORT IN/OUT Field

#### PORT OUT

PORT OUT is used to enable an external device from another module in the intermodule configuration tree. To configure a PORT OUT signal, do the following:

- 1 Select the **PORT IN/OUT** field above the module field, then select the **PORT OUT** field from the PORT IN/OUT Setup menu that appears.
- 2 From the selection list choose the module you want the signal to come from.

The selection list will contain the names of all the modules configured in the group run. A "PO" indicator will appear in the configuration tree originating from the module you select.

The PORT OUT signal is a positive-going TTL pulse whose width varies depending on the module that is driving it. The port may be terminated by a 50  $\Omega$  load to reduce ringing, however, the signal will then be less than or equal to 0.4 V when low and at least 2.0 V when high.

### PORT IN

With a trigger signal connected to the PORT IN BNC on the rear panel, the intermodule measurement can be started with this signal after preset voltage and edge criteria is met. To configure a PORT IN signal, do the following:

- 1 Select the **PORT IN Level** field and set the level to TTL, ECL, or a User defined level between +5 V and -4 V.
- 2 Select the **PORT IN Edge** field and toggle the edge type to either Rising or Falling.
- 3 After the PORT IN voltage level and edge criteria is set, select the **Group Run/Stop** field. The analyzer will wait until the proper signal is seen at the PORT IN BNC before the measurement begins.

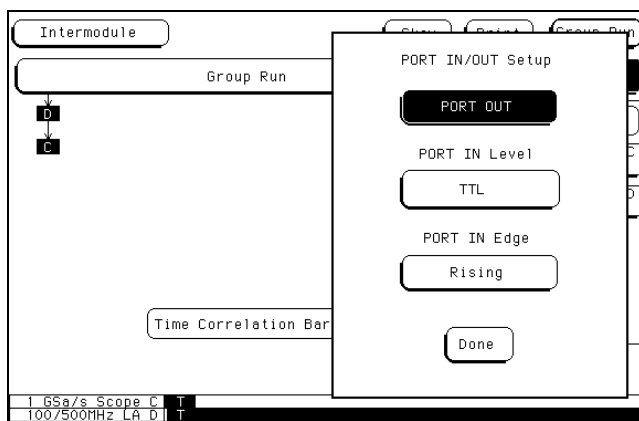

### PORT IN/OUT Setup Menu

Only the HP 16500B has the PORT IN BNC. However, the PORT IN signal is available to modules in both the HP 16500B and HP 16501A frames.

When using PORT IN, an external device must be connected to the PORT IN BNC on the rear panel. If an external device isn't connected, or is accidentally disconnected, the instrument will not trigger.

---

## The Group Run/Stop Field

When a module is added to the intermodule configuration tree, that module's Run/Stop field changes to the Group Run/Stop field. A Group Run/Stop field is also available in the Intermodule menu. This field starts an acquisition just like any individual module's Group Run/Stop field. When an acquisition is started in the intermodule menu, you can monitor the results with the Running/Stopped status indicators and time-correlation bars.

When you select the **Group Run/Stop** field, a pop-up appears with two choices for acquiring data.

- **Single**, which is the default, allows you to run the measurement once.
- **Repetitive** allows you to run the measurement as many times as you want to collect data for statistical measurements, etc. Press **Stop** when you want to stop a repetitive run.

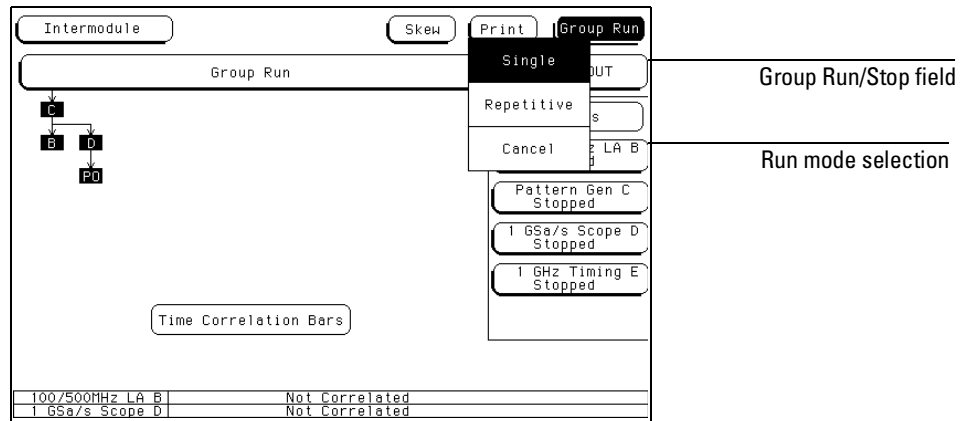

### Group Run/Stop Field

## The Modules List

On the right side of the screen are fields listing the different modules that can be configured in the Intermodule menu. When you select one of the module fields, a pop-up appears displaying the possible locations of the module in the intermodule configuration tree.

- Independent allows the module to run independently of the other modules and removes it from the intermodule configuration tree.
- Group Run places the module directly below the large Group Run Configuration field. This module is armed immediately after the Group Run/Stop field is touched.
- The other fields in the pop-up list the name of the modules that are already part of the intermodule configuration tree, and can be used to arm this module. Selecting one of these fields places the current module below the module indicated by the field you selected. The current module is then armed when the preceding module finds its trigger.

After you make your selection, a box appears in the intermodule configuration tree with the module's slot location (A through E for the HP 16500B alone, or A through J for the HP 16500B with the HP 16501A attached) representing the location of the module in the tree.

The screenshot shows the 'Intermodule' configuration screen. At the top, there are buttons for 'Independent', 'Print', and 'Group Run'. Below these is a 'Group Run' section with a tree view showing a hierarchy: 'C' (parent), 'B' and 'D' (children of C), and 'PO' (child of D). To the right of the tree is a list of modules: 'Group Run', '100/500MHz LA B', 'Pattern Gen C', and '1 G5a/s Scope D'. Below the tree is a 'Time Correlation Bars' section. At the bottom, there is a table with two rows:

100/500MHz LA B	Not Correlated
1 G5a/s Scope D	Not Correlated

### The Module Pop-up Menu

---

## Status Indicators and Time Correlation Bars

The message "Running" or "Stopped" appears below the names of the individual modules that are listed on the right side of the Intermodule menu. This indicates the current status for each module and can be used to monitor the intermodule measurement. If there is a problem with the measurement, a quick check of these status indicators can show you which modules have completed their operations (Stopped) and which ones are still running. Generally:

- If a module was running and is stopped now, you can assume it received its arm signal and triggered properly.
- If a module located below a stopped module on the intermodule configuration tree has received an arm signal and is still running, it is still looking to satisfy its trigger specification.
- If a module below a running module on the intermodule configuration tree has not received its arm signal, it will not begin running.

The time correlation bars at the bottom of the menu display the start and stop time of each module relative to the other modules.

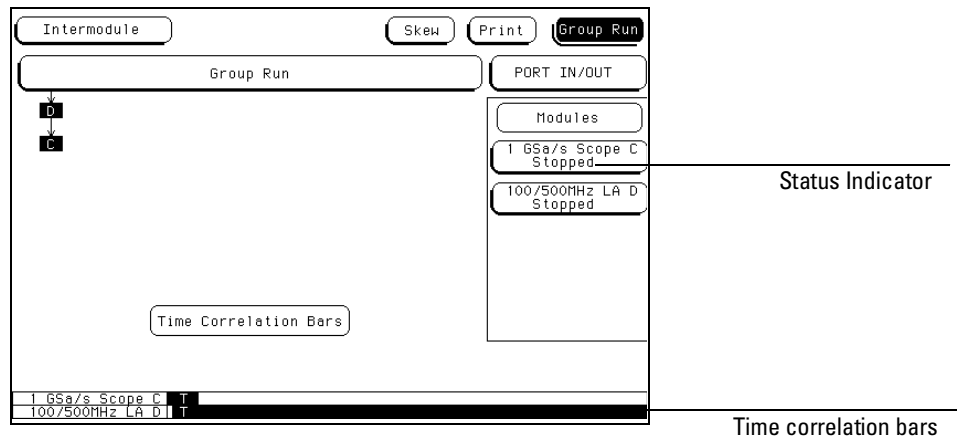

**Status Indicators/Time Correlation Bars**

## Adjusting Skew

Selecting the Skew field brings up the Intermodule Skew menu.

The Intermodule Skew menu is used to skew waveforms or state listings between modules on the display. This allows for display adjustment to within 2 ns between modules. The major purpose of this adjustment is to compensate for variances in internal probing delays across modules.

To adjust the skew of the module, select the individual module within the Skew menu and add or subtract a known time value. This value may be calculated with the markers by measuring the skew between some common signals sampled by both modules.

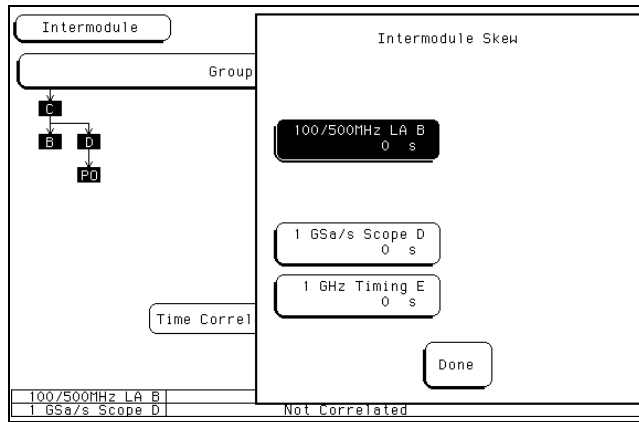

The Skew Pop-up

# Intermodule Measurements

## What Are Some Typical Intermodule Measurements?

### What Are Some Typical Intermodule Measurements?

Intermodule measurements may be as simple as starting several modules at once, or very complex with multiple armoring sequences between modules and external equipment. Some examples are:

#### Example

#### Analyzing a Glitch

A glitch is defined as two or more transitions between the samples of a timing analyzer that cross the logic threshold. A timing analyzer can trigger on a glitch and capture it, but doesn't have the voltage or timing resolution to look at the glitch in detail. On the other hand, an oscilloscope can acquire waveform with a great deal of resolution, but it can't trigger on glitches, combinations of glitches, or patterns.

To analyze a glitch, use a timing analyzer and an oscilloscope interactively. Set up the timing analyzer to trigger on a glitch and when the timing analyzer triggers, capture the glitch with the oscilloscope. Then use the oscilloscope to look at the waveform parameters of the glitch, including its width, shape, and amplitude.

For this intermodule measurement, you are using the triggering capabilities of the timing analyzer and the acquisition capabilities of the oscilloscope.

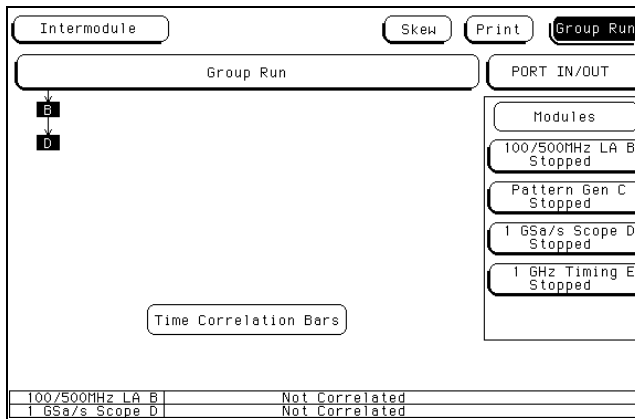

#### Glitch Example

---

**Example**

**Analyzing Interrupt Handling in a CPU System**

Most microprocessor programs can be interrupted by an asynchronous hardware signal. Software designers are interested in the processor's real-time response to interrupts. In particular, you need to answer these kinds of questions:

- Does the processor branch to the proper interrupt handling routine?
- Are registers and status information saved properly?
- How long does it take to service the interrupt?
- Is the interrupt acknowledged properly?
- After the interrupt is serviced, does the processor restore registers and status information and continue with the previous routine as expected?

Usually, software designers want to look at the program flow of the microprocessor system around an asynchronous event.

A state analyzer, coupled with a preprocessor and an inverse assembler, is useful for tracing the flow of a microprocessor program. A timing analyzer or an oscilloscope is designed to trigger on asynchronous events like edges.

In this example, use an oscilloscope with a sample rate faster than the microprocessor clock to trigger on the asynchronous event and to arm the state analyzer. Then use the state analyzer to check the address of the interrupt routine. You may also use the state analyzer to see if the microprocessor is properly servicing interrupts and returning to the correct address after each interrupt routine.





## Intermodule Measurements

### What Are Some Typical Intermodule Measurements?

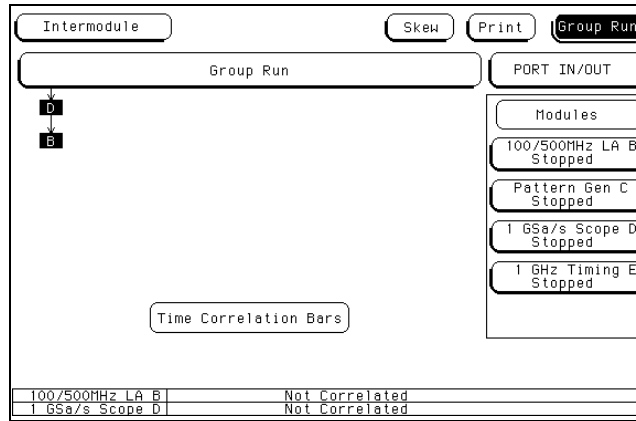

#### Interrupt Handling Example

Set up the oscilloscope to trigger on the asynchronous interrupt line. This is usually an edge-sensitive line on which the oscilloscope can trigger.

The state analyzer should be armed by the oscilloscope. Set the state analyzer to trigger on all "don't cares" and it will capture the interrupt service routine when the arm signal is received. For this intermodule measurement, arming the state analyzer with the oscilloscope allows a software designer to track the flow of a microprocessor program around a hardware interrupt.

#### Example

#### A Simple Stimulus Response System

During system development, designers are often faced with verifying a part of a design when the input signals for that part are unavailable. Here are some common examples of this problem:

- Verifying hardware operation when a part of the hardware is unavailable to drive the circuit.
- Testing a PC board without a board test system.

The traditional solution is to use word generators to emulate the missing part of the design, and to use logic analyzers and oscilloscopes to capture the system response.

## Intermodule Measurements What Are Some Typical Intermodule Measurements?

Unfortunately, designers are often faced with an awkward solution of stacking several boxes on top of each other, with a maze of cables tying them together, and a different interface for each instrument.

The pattern generator in the HP 16500B can act as the stack of word generators in this problem. State, timing, and analog modules can all be used to capture the response of the system.

The pattern generator is loaded with the proper patterns and when it starts sending patterns, it sends an arm signal over the intermodule bus.

The acquisition modules are armed from the pattern generator module and set to trigger on the appropriate event in the system.

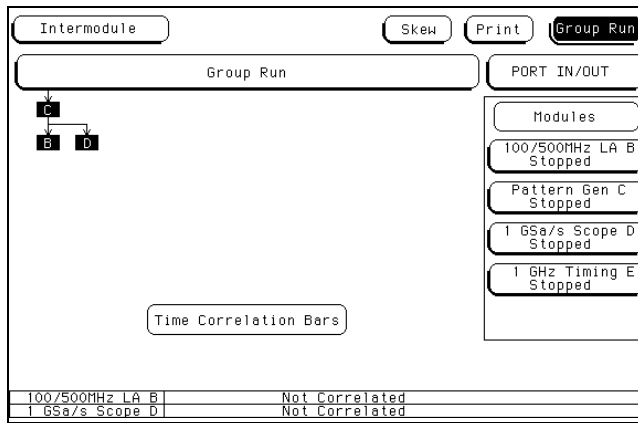

### Stimulus/Response Example

## Displaying Multiple Module Data on One Screen

When you are making intermodule measurements, you can display the resulting waveforms or state listings for several modules together on one screen. For example, to display waveform data for an oscilloscope and a timing analyzer on an oscilloscope menu, the procedure below may be followed. You may not have the exact same configuration of modules, however, the procedure steps will be similar.

- 1 Select the module field in the upper-left corner of the screen.
- 2 When the pop-up appears, select the HP 16532A **Oscilloscope** module.
- 3 When the oscilloscope menu appears, select the menu in which you want to view the data (for this example, **Auto-Measure**).
- 4 Select the **channel label** field to the left of the waveform display once to scroll the waveforms. Select this field again to access the display parameters.

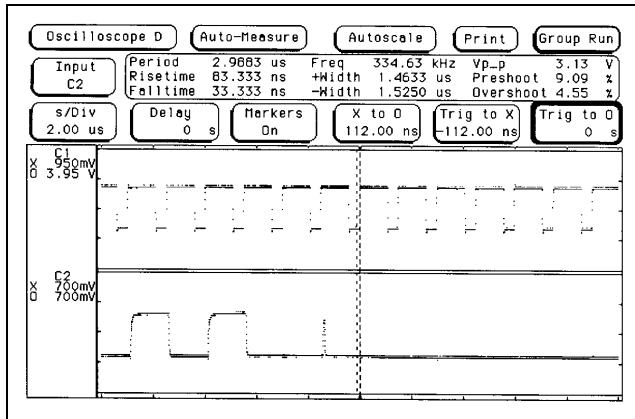

Selecting the Waveform Selection Pop-up

- 5 When the **Waveform Selection** pop-up appears, select the field displaying **Module Oscilloscope D**.
- 6 When the pop-up appears, select **State/Timing E**. After the pop-up disappears, the appropriate labels for the channels of the HP 16550A State/Timing Analyzer will be listed under the State/Timing E field.

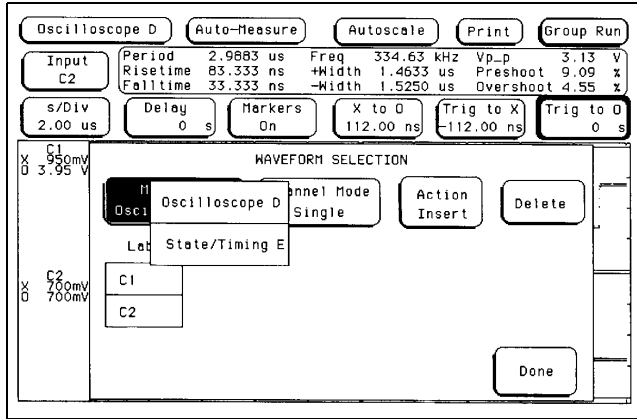

**Selecting State/Timing E**

Intermodule Measurements  
**Displaying Multiple Module Data on One Screen**

- 7 Select the labels for the channels that you want displayed. For this example, select **OUT\_4**.

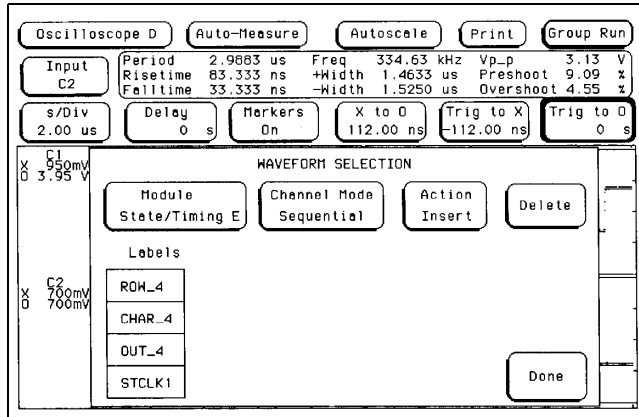

**Selecting HP 16510B Channels**

- 8 Select **Done** and the Waveform Selection pop-up will disappear, returning you to the waveform display. As shown in the figure below, the five HP 16550A timing analyzer channels (OUT\_4) are now displayed with the HP 16532A oscilloscope channels C1 and C2 on the Oscilloscope D Auto-Measure menu.

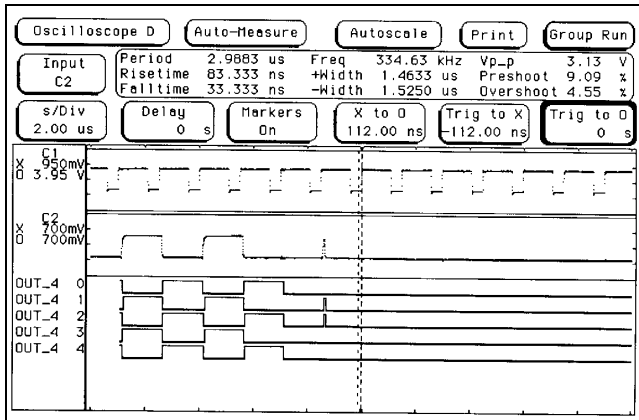

**Displaying Multiple Module Data on One Screen**

---

## Helpful Hints

- When setting up measurements, start with simple setups and work up to more complex ones. For example, set up the module that will trigger first and take a measurement with only this module. Once you've verified that this first trigger works properly, start adding additional modules to be armed by this trigger.
- Before starting the measurement, setup a simple trigger condition, then set all modules to store data while they search for the trigger condition. This way, you can see information on both sides of the trigger condition as you fine-tune the measurement.
- For complex triggering between modules, initially set the modules that are armed from the intermodule bus to trigger on all "don't cares" or to "trigger immediately." Then increase the triggering requirements in stages by starting with the first modules that are armed and working from the top to the bottom of the intermodule configuration tree.







General  
Characteristics



---

## General Characteristics

This chapter describes the general characteristics of the HP 16500B/16501A Logic Analysis System, including hardcopy capability, the input/output rear panel BNCs, and information about making interactive measurements. This chapter also includes the weight and dimensions of the HP 16500B/16501A, and information about the operating environment necessary to ensure optimum equipment performance.

---

### Characteristics

These characteristics are not specifications, but are included as additional information. The following characteristics are typical for the HP 16500B/16501A system.



#### Hard Disk Drive

**Capacity** 85 Mbyte unformatted; Formatted as a Microsoft<sup>®</sup> DOS disk drive IDE Interface Bus

#### Flexible Disk Drive

**Capacity** 1.44 Mbyte formatted, Microsoft DOS or LIF supported.

#### Programmability

Instrument settings and operating modes, including automatic measurements, may be remotely programmed via RS-232C, HP-IB (IEEE-488), or optional HP 16500L (Ethernet).

#### Hardcopy Output

**Printers Supported** HP ThinkJet, HP QuietJet, HP LaserJet, HP PaintJet, HP Deskjet, HP Deskjet C, Epson and Epson-compatible (for example Epson FX-80) via RS-232C or HP-IB.

**RS-232C Configurations** Protocols: XON/XOFF, Hardware; Data bits: 8; Stop bits: 1, 1 1/2, 2; Parity: none, odd, or even; Baud rates: 110, 300, 600, 1200, 2400, 4800, 9600, 19200.

**HP-IB Interface Functions** SH1, AH1, T5, TE0, L3, LE0, SR1, RL1, PP1, DC1, DT1, C0 and E2.

**Input/Output  
Rear Panel BNCs:**

**Port-in** User selectable: TTL, ECL or user defined;  $Z_{in} = 4\text{ k}\Omega$  ;  
 $V_{in} = -4.0\text{ V}$  at 1.5 mA to +5 V at 1.6 mA.

**Port-out** Output signal is active high, TTL output level, high > 2 V into  
50  $\Omega$ , low < 0.4 V into 50  $\Omega$ .

**Intermodule Bus  
(IMB)  
Characteristics**

**Run Control** Oscilloscope, timing, state, and pattern generation can be  
armed by Group Run. Modules can run concurrently or be armed in  
series. Each module can arm one or more modules.

**Mixed Display Mode** Any timing or oscilloscope waveform displays  
can be mixed. State listings can be included with waveforms in the  
State/Timing Mixed Mode display.

**Acquiring Data for Mixed Displays** To obtain a mixed display,  
multiple modules must be armed through the IMB. To include state  
listings in mixed mode displays, state time tagging must be on.

**Time Interval Accuracy Between Modules** Equals the sum of the  
channel-to-channel time interval accuracies of each module used in the  
measurement, for a deskewed measurement.

**Time Correlation Resolution** 2 ns (500 MHz)

**Operating  
Environment**

**Temperature**

**Instrument** 0 °C to 50 °C (32 °F to 122 °F).

**Disk Media** 10 °C to 40 °C (50 °F to 104 °F).

**Probes and Cables** 0 °C to 65 °C (32 °F to 149 °F).

**Humidity**

**Instrument** up to 95% relative humidity at 40 °C (104 °F).

**Disk media and hard drive** 8% to 80% relative humidity at 40 °C  
(104 °F).

**Altitude** Up to 4600 m (15 000 ft). Hard drive to 300 m (10,000 ft).

General Characteristics  
**Characteristics**

**Vibration**

**Operating** Random vibration 5-500 Hz, 10 minutes per axis, 2.41 g (rms.)

**Nonoperating** Random vibration 5-500 Hz, 10 minutes per axis, ~ 2.4 g (rms); and swept sine resonant search, 5-500 Hz, 0.75g (0-peak), 5 minute dwell at 4 resonances per axis.

**Power** 115 V/230 V, 48-66 Hz, 475 W max.

**Weight**

**HP 16500B**

**Net** 18.1 kg (40 lbs) + (0.7 kg (1.6 lbs) x number of optional cards installed).

**Shipping** 25.9 kg (57 lbs) + (3.6 kg (8 lbs) x number of optional cards installed).

**HP 16501A**

**Net** 12.2 kg (27 lbs) + (0.7 kg (1.6 lbs) x number of optional cards installed).

**Power Requirements**

**HP 16500B** 115 V/230 V, 48 to 66 Hz, 475 W max.

**HP 16501A** 115 V/230 V, 48 to 66 Hz, 420 W max.

**Dimensions**

Refer to the following figure for dimensional detail.

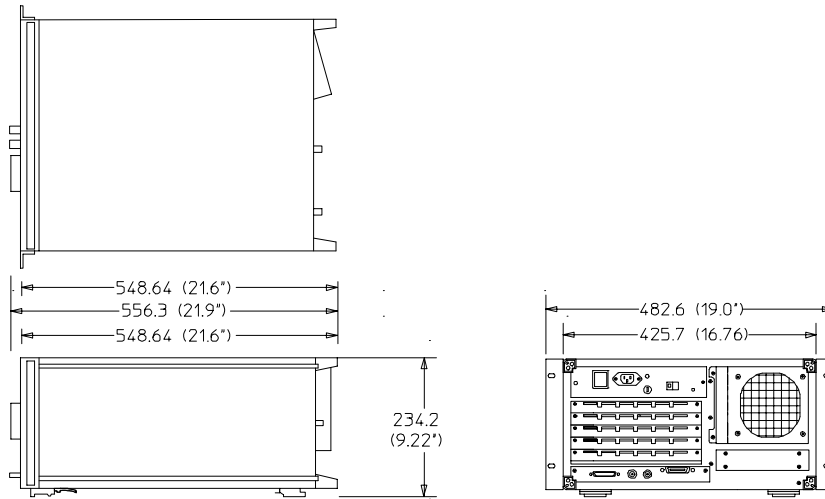

HP 16500B

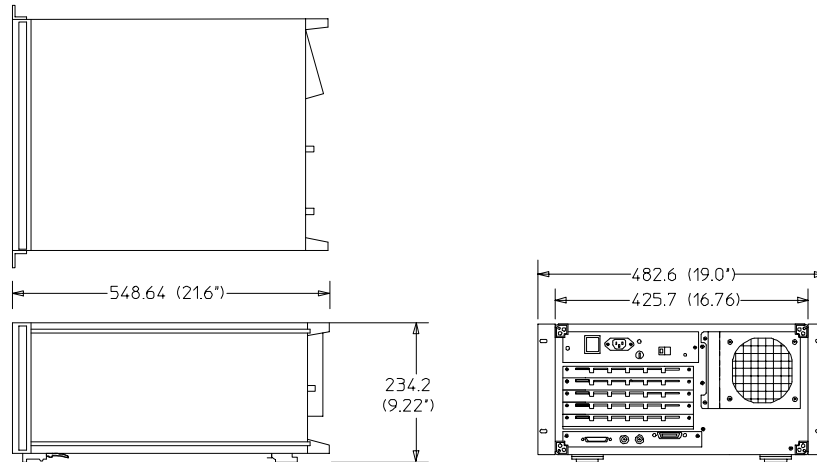

HP 16501A

16500E52

**Dimensional Detail**





M aintaining the  
H P 16500B

---

## M aintaining the H P 16500B

This chapter describes the m aintenance requirem ents for the HP 16500B Logic Analysis System . It explains cleaning requirem ents and degaussing procedures , and tells you where to look for inform ation when the instrum ent needs service or recalibration . It also explains how the System Testm enu is used .

---

### C leaning R equirem ents

W hen cleaning the HP 16500B , USE MILD SOAP AND WATER only. A harsh soap or solvent m ay dam age the water-base paint finish .

C lean the CRT display and surrounding area regularly . DO NOT place tape or other foreign m aterial on the screen .

Vacuum the ventilation slots on the sides of the instrum ent and the fan on the rear panel whenever there is a visible am ount of dust on them .

---

## Degaussing

After you have used the instrument for a while, the CRT may become magnetized and start to distort the colors on the screen or other display data. To remedy this problem, simply degauss the CRT by pressing and releasing the button on the rear panel marked DEGAUSS. If the screen is in particularly bad condition, repeat this procedure several times until the screen clears up.

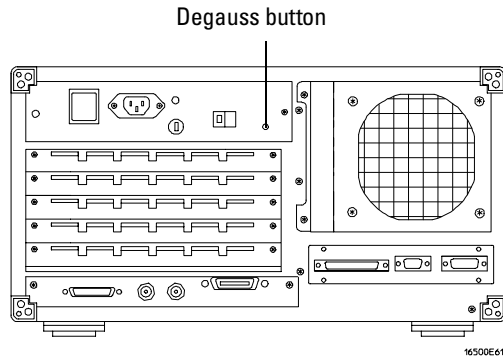

### The Degaussing Button

---

## Service and Calibration

If at any time the instrument fails to operate properly or needs to be adjusted, refer to the *HP 16500B Service Guide*.



---

## The System Test Menu

The System Test menu is used to test portions of the microprocessor board including the system peripheral interfaces and the disk drives. It also allows you to check the color module for color purity. For more information on this menu, refer to the *HP 16500B Service Guide*.

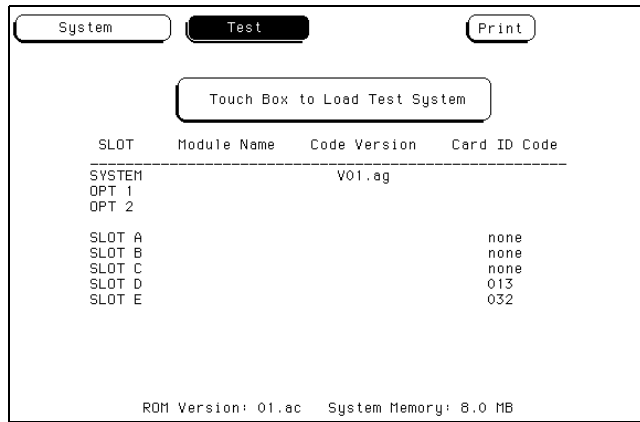

### Loading the Test System Software

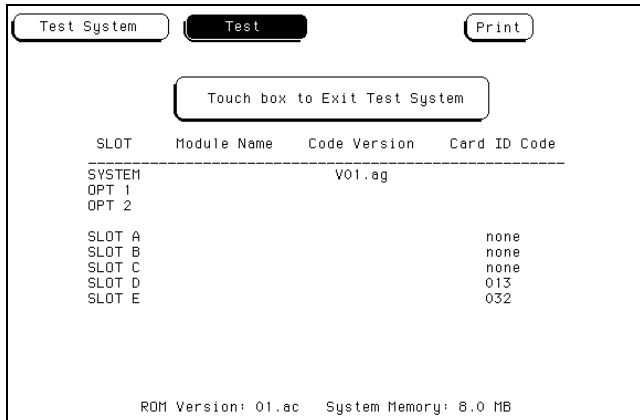

### Reloading the Mainframe System

## Repackaging for Storage or Shipment

Proper repackaging is necessary to prevent damage to the HP 16500B. The instrument may be stored or shipped in environments within these limits:

### **Temperature**

40 to 70 degrees C (–40 to +158 ° F)

### **Humidity**

Up to 90% relative humidity at 65 ° C  
(149 ° F)

### **Altitude**

Up to 15,300 m (50,000 ft)

The instrument should also be protected from temperature extremes which could cause condensation within the instrument. Condensation within the instrument may cause it to malfunction.

### **Tagging the Instrument for Service**

If the instrument is to be shipped to a Hewlett-Packard office for service or repair, attach a tag with the owner's name and address, the model number, the complete serial number, and a description of the service required. In any correspondence, refer to the instrument by model number and serial number.

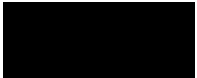

## Maintaining the HP 16500B Repackaging for Storage or Shipment

### Repacking the Instrument

Before repacking the instrument, insert a shipping disk into the flexible disk drive. The shipping disk helps protect the disk drive from damage during shipping.

If the original packing material is unavailable or unserviceable, material identical to factory packaging is available through Hewlett-Packard offices. Always mark the container **FRAGILE** to ensure careful handling.

If you use other packaging, follow these general instructions:

- 1 Wrap the instrument in heavy paper or plastic.
- 2 Use a strong shipping container. A double-wall carton made of 350-lb test material is adequate.
- 3 Protect the control panel with a piece of cardboard.
- 4 Put a layer of shock-absorbing material 70- to 100-mm (3- to 4-in.) thick around the instrument to firmly cushion it and prevent any movement inside the container.
- 5 Seal the shipping container securely.
- 6 Mark the container **FRAGILE** to ensure careful handling.



Error Messages

---

## Error Messages

This chapter lists the disk error messages and disk warning messages you may receive while operating the disk menus in the HP 16500B/16501A Logic Analysis System. In addition, there is information on the powerup self tests errors.

## Disk Error Messages

The following is a list and description of error messages that may be displayed in the disk menus.

**Configuration not loadable** This module or option does not have the ability to load a configuration.

**Configuration not storable** This module or option does not have the ability to store a configuration.

**Destination disk has different capacity** The disk drive only permits the duplicate disk operation between floppy diskettes with the same capacity (double density or high density) and format (LIF or DOS).

**Directory contains files** You cannot purge a directory that contains files. Delete all files within the directory first, then purge the directory.

**Directories not supported on LIF disk** Directory operations may not be performed on LIF disks.

**Disk CRC error** Cyclical Redundancy Check (CRC) failed on this disk. Try to recover any needed files and reformat the disk. Formatting the disk may not correct the current problem. If it doesn't correct the problem, discard the disk.

**Disk data lost** Unable to read the disk. Try re-installing the disk or cycling the power.

**Disk is write-protected** The current disk is write-protected. Disengage the write-protect tab on the disk.

**Disk record not found** The disk format has been damaged. Recover any needed files and reformat the disk. Formatting the disk may not correct the current problem. If it doesn't correct the problem, discard the disk.

**Disk timeout** The disk drive may not be working properly or the media was removed while being accessed.

**Duplicate filename** A file with the same name already exists on the current disk. Select a different destination name.

## Error Messages

### Disk Error Messages

**End of file encountered** Trying to read data beyond the end of the file. The file was generated improperly or its contents have been altered.

**File is being used** You cannot purge a file or directory that is being used by another operation. Operations may be initiated using the touch screen, controller, or ethernet. Finish the other operation and try your operation again.

**File not found** The specified file is not on the disk. Also, when copying a file, the directory that contains the destination file may not exist.

**Filename already exists** A file with the same name already exists on the current disk. Select a different destination name.

**Insufficient memory** There is not enough memory to perform the selected operation at this time. Reduce the number of operations being performed on the logic analyzer (using the touch screen, controller, or ethernet) and try the operation again.

**Invalid configuration file** The contents of this file are incorrect.

**Invalid filename** The filename is invalid for any of the following reasons. The name contains invalid characters for the disk format (LIF or DOS). The name is too long. The filename has spaces inbedded in the wrong places.

**Invalid file type for this operation** The current operation may not be performed with a file of the current type.

**No destination disk** No disk is currently installed in the destination disk drive.

**No disk** No disk is installed in the flexible disk drive.

**No room in directory** The directory on the disk is full. Purge any files no longer needed.

**No room on disk** The disk is full and the currently written file does not fit. Deleting unneeded files and/or packing the disk may correct the problem.

**Permission for this operation denied** The logic analyzer does not permit certain operations: duplicating the hard disk, formatting the hard disk in LIF format, or writing or purging a file that has its read-only attribute set.

**Selected file is incompatible** The file being loaded is incompatible for this module or option.

**Too many files open** The logic analyzer's maximum number of simultaneously open files has been exceeded. File operations may be initiated from the touch screen, the controller, or the ethernet. Reduce the number of file operations and try again.

**Unsupported disk format** The disk in the disk drive is unformatted or formatted on a non-compatible system. If the contents of the disk are NOT needed, format it.

**Wrong format on high density diskette** A high density (black) diskette has been formatted with a double density format. The logic analyzer cannot read this diskette.

---

## Disk Warning Messages

Disk warning messages are displayed when the contents of a file or a disk are in danger of being destroyed by an operation.

**Duplicate Disk destroys contents of destination** A warning that the duplicate disk command does not append the source files to the destination. It overwrites any files on the destination disk in a packed form.

**Filename must begin with a capital letter** This warning indicates that the disk will not accept the filename as it has been entered. Retype the filename with a capital letter at the beginning.

**Embedded blanks not allowed in filename** This warning indicates that the disk will not accept the filename as it has been entered. Remove the blank spaces or replace them with an underscore character.



## Powerup Self-Test Documentation

When you turn on the HP 16500B it initiates a set of self-tests to check the basic condition of the instrument and the operating system. This is a limited set of tests that checks whether or not the CPU board is working well enough to boot the rest of the software from disk.

If a test fails, consult your *HP 16500B Service Guide*.

No self-test routines are performed for any modules at power-up. The following is a list of self tests performed.

© COPYRIGHT 1992 HEWLETT-PACKARD COMPANY HP 16500B V XX XX

### PERFORMING POWERUP SELF TESTS

passed ROM Test  
passed RAM Test  
passed Interrupt Test  
passed Display Test  
passed HIL Controller Test  
passed Front Panel Test  
passed Touch Screen Test  
passed Correlator Test  
passed Hard Disk Test  
passed Flexible Disk Test

LOADING SYSTEM FILES

LOADING MODULE FILES

LOADING SOFTWARE OPTIONS

AUTOLOADING CONFIGURATION

---

## FailCodes

The type of failcodes you might encounter are:

<b>D isk T est</b>	passed failed no disk - Install a disk or re-install the current disk.
<b>T ouchscreen</b>	passed in paired -Not a complete touchscreen, but the instrument can still be operated; or the touch failed, but a mouse was detected on the interface top. Try wiping the bezel on the display and cleaning the CRT. Make sure no objects are blocking the screen on power-up. failed -Not enough touchscreen to operate the instrument (major failure).
<b>A ll O thers</b>	Passed or Failed

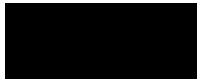

## Critical Errors

Critical errors are system load errors detected at power-up. When one of these is detected, they are displayed on the screen in yellow and the self-test routine is stopped IMMEDIATELY. These include:

**SYSTEM FILE NOT FOUND** Indicates the last drive searched for a system file had a disk, but no system file was found on the disk.

**SYSTEM DISK NOT FOUND** Indicates the last drive checked had no disk on it.

**SYSTEM FILE READ ERROR** Indicates an error was detected during all three attempts to load the system file.

**SYSTEM DISK ERROR** Indicates the drive that the system file was on failed during load.

---

## Non-Critical Errors

Non-critical errors allow sequences to continue and won't stop the power-up routine. These include "in paired" and "no disk."

- A**
  - Address, selecting, 3-4
  - Autobad, 5-2
    - enabling, 5-17
- B**
  - Baud rate
    - defined, 3-5
    - setting, 3-5
- C**
  - Calibration, 9-3
  - Cleaning instructions, 9-2
  - Clock, setting, 6-6
  - Cobr
    - for display, 6-12
    - returning to defaults, 6-14
    - selecting, 6-10
  - Cobrm odel, 6-8
  - Configuration tree, 7-18
  - Controller interface, defined, 3-3
  - Copy, 5-2, 5-20
- D**
  - Data bits
    - defined, 3-7
    - supported, 3-7
  - Default configuration
    - defined, 1-4
    - storing, 1-4
  - Degaussing, 9-3
  - Description of analyzer, 1-2
  - Disk drive
    - autobad a file, 5-17 to 5-18
    - copy a file, 5-20 to 5-21
    - duplicate a disk, 5-23
    - pack a disk, 5-22
    - purge a file, 5-19
    - select an operation, 5-7
    - store a file, 5-12 to 5-14
  - Disk Drive Operations, 5-2
  - Disk operations
    - autobad, 5-2, 5-17 to 5-18
    - change directory, 5-25
    - copy, 5-2, 5-20 to 5-21
    - default values, 5-8, 5-10, 5-12, 5-15
    - duplicate disk, 5-2, 5-23
    - format disk, 5-2, 5-10 to 5-11
    - bad, 5-3, 5-8 to 5-9
    - make directory, 5-24
    - pack disk, 5-3, 5-22
    - purge, 5-3, 5-19
    - rename, 5-3, 5-15 to 5-16
    - selecting, 5-7
    - store, 5-3, 5-12 to 5-14
  - Disks
    - duplicating, 5-23
    - formatting, 5-10
    - packing, 5-22
    - storing files on, 5-12
  - Display
    - multiple module data on one screen, 7-18
    - printing, 4-11
    - selecting color for, 6-12
  - Duplicate disk, 5-2, 5-23
- E**
  - Environment
    - storage, 9-5
  - Epson printers, 4-3
- F**
  - File identification code, 5-26
  - File types, 5-15
  - Files
    - copying, 5-20
    - identification code, 5-26
    - loading, 5-8
    - purging, 5-19
    - renaming, 5-15
    - storing, 5-12
  - Format a disk, 5-10 to 5-11
  - Format disk, 5-2, 5-10
  - Formatting, 5-10 to 5-11
- G**
  - Group Run
    - for HP 16500B, 7-6
  - Group Run/Stop
    - repetitive, 7-10
    - using, 7-10
- H**
  - HP 16500A
    - defined, 1-2
    - key features, 1-3
    - optional features, 1-3
    - tagging for service, 9-5
  - HP 16500B
    - repacking, 9-6
  - HP 16501A
    - defined, 1-2
  - HP -IB interface
    - configuring, 3-8
    - defined, 3-4
    - Listen Always, 3-8
    - selecting an address, 3-4
  - HP -IB printers
    - configuration, 4-4
    - Listen Always, 4-3 to 4-4
    - setup, 4-3
    - supported, 4-3
  - Hue
    - defined, 6-8
    - selecting, 6-10
- I**
  - Inter module measurements
    - accessing, 7-18
    - analyzing a glitch, 7-14
    - analyzing interrupt handling, 7-15
    - helpful hints, 7-21
    - simple stimulus/response, 7-16
  - Inter module menu
    - accessing, 7-5
    - configuring, 7-18
    - described, 7-2
    - menu map, 7-4
- K**
  - Key analyzer features, 1-3
  - Knob
    - use of, 1-4
- L**
  - Listen Always, 3-8, 4-3 to 4-4
  - Load, 5-3, 5-8
  - Logic Analysis System
    - defined, 1-2
    - maintenance, 9-2
  - Luminosity
    - defined, 6-8
    - selecting, 6-10

- 
- M**
  - Maintenance
    - calibration, 9-3
    - cleaning requirements, 9-2
    - degaussing, 9-3
  - Menu maps
    - disk menu, 5-4
  - Modules
    - adjusting skew, 7-13
    - displaying data on screen, 7-18
    - locations in configuration tree, 7-11
    - status of, 7-12
  - Mouse
    - use of, 1-4
  - O**
  - Optional features, 1-3
  - P**
  - Pack disk, 5-3, 5-22
  - Packing material, 9-6
  - Parity
    - defined, 3-6
    - selecting, 3-6
  - Performance Verification Software, 5-26
  - Port out
    - BNC connection, 7-9
    - use of, 7-18
  - Print all, 4-11
  - Print disk, 4-11
  - Print line, 4-11
  - Print partial, 4-11
  - Print record, 4-11
  - Print screen, 4-11
  - Printer interface, defined, 3-3
  - Printers
    - alternate, 4-4, 4-8
    - EpsonB, 4-3
    - HP-IB, 4-3
    - other HP, 4-9
    - RS-232C, 4-6
    - supported, 4-2
  - Printing the display, 4-11 to 4-12
  - Protocol
    - defined, 3-7
  - Purge, 5-3, 5-19
  - R**
  - Rename, 5-3, 5-15
  - RS-232C interface
    - configuring, 3-8
    - defined, 3-5
  - RS-232C printers
    - configuration, 4-8
    - mode configuration switches, 4-7
    - supported, 4-6
  - S**
  - Saturation
    - defined, 6-8
    - selecting, 6-10
  - Screen brightness, 1-4
  - Screen contrast, 1-4
  - Service, 9-3
  - Shipping container, 9-6
  - Shipping disks, 9-6
  - Skew
    - adjusting, 7-13
  - Skew menu
    - accessing, 7-13
    - use of, 7-13
  - Sbt designators
    - defined, 2-6
  - Sound
    - turning off, 6-7
    - turning on, 6-7
  - Status indicators, 7-12
  - Stop bits
    - changing, 3-6
    - defined, 3-6
  - Storage environment, 9-5
  - Store, 5-3, 5-12
  - System Configuration Menu
    - accessing, 2-4
    - defined, 2-2
    - layout, 2-5
    - menu map, 2-3
    - sbt designators, 2-6
  - System Disk Menu
    - menu map, 5-4
  - System options, 1-2
  - System Test Menu, 9-4
  - System Utilities Menu
    - accessing, 6-2
    - described, 6-2
    - menu map, 6-3
    - sound, 6-7
    - touch calibration, 6-4
  - T**
  - Time correlation bars, 7-12
  - Touch calibration, 6-4
  - Touch on/off button, 1-4
  - Touchscreen
    - calibrating, 6-4
    - on/off, 6-5
    - use of, 1-4
  - U**
  - User interfaces, 1-4
    - knob, 1-4
    - mouse, 1-4
    - touchscreen, 1-4
  - W**
  - Waveforms, selecting, 7-19

# DECLARATION OF CONFORMITY

according to ISO /IEC Guide 22 and EN 45014

**Manufacturer's Name:** Hewlett-Packard Company

**Manufacturer's Address:** 1900 Garden of the Gods Road  
Colorado Springs, CO 80901  
U.S.A.

## Declares, That the product

**Product Name:** HP 16500B Logic Analysis System

**Model Number(s):** HP 16500B

**Product Options:** All

## Conforms to the following Product Specifications:

**Safety:** IEC 348 /HD 401  
UL 1244  
CSA -C22.2 No. 231 Series M-89

**EMC:** CISPR 11:1990 /EN 55011 (1991): Group 1 Class A  
IEC 801-2:1991 /EN 50082-1 (1992): 4 kV CD, 8 kV AD  
IEC 801-3:1984 /EN 50082-1 (1992): 3 V/m  
IEC 801-4:1988 /EN 50082-1 (1992): 1 kV

## Supplementary Information:

The product herewith complies with the requirements of the Low Voltage Directive 73/23/EEC and the EMC Directive 89/336/EEC.

Colorado Springs, May 1, 1993

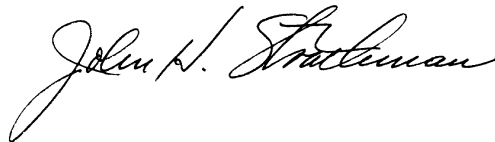

European Contact: Your local Hewlett-Packard Sales and Service Office or Hewlett-Packard GmbH,  
Department ZQ /Standards Europe, Herrenberger Straße 130, D-7030 Böblingen (FAX: +49-7031-143143)



© Copyright Hewlett-Packard Company 1987, 1990, 1993, 1994  
All Rights Reserved.

Reproduction, adaptation, or translation without prior written permission is prohibited, except as allowed under the copyright law s.

#### Document Warranty

The information contained in this document is subject to change without notice.

**Hewlett-Packard makes no warranty of any kind with regard to this material, including, but not limited to, the implied warranties or merchantability and fitness for a particular purpose.**

Hewlett-Packard shall not be liable for errors contained herein or for incidental or consequential damages in connection with the furnishing, performance, or use of this material.

Complete product warranty information is given on the last page of this guide.

#### Safety

This apparatus has been designed and tested in accordance with IEC Publication 348, Safety Requirements for Measuring Apparatus, and has been supplied in a safe condition. This is a Safety Class I instrument (provided with terminal for protective earthing). Before applying power, verify that the correct safety precautions are taken (see the following warnings). In addition, note the external markings on the instrument that are described under "Safety Symbols."

#### Warning

- Before turning on the instrument, you must connect the protective earth terminal of the instrument to the protective conductor of the (mains) power cord. The mains plug shall only be inserted in a socket outlet provided with a protective earth contact. You must not negate the protective action by using an extension cord (power cable) without a protective conductor (grounding). Grounding one conductor of a two-conductor outlet is not sufficient protection.
- Only fuses with the required rated current, voltage, and specified type (nominal blow time delay, etc.) should be used. Do not use repaired fuses or short-circuited fuseholders. To do so could cause a shock or fire hazard.

- Service instructions are for trained service personnel. To avoid dangerous electric shock, do not perform any service unless qualified to do so. Do not attempt internal service or adjustment unless another person, capable of rendering first aid and resuscitation, is present.

- If you energize this instrument by an auto transformer (for voltage reduction), make sure the common terminal is connected to the earth terminal of the power source.
- Whenever it is likely that the ground protection is impaired, you must make the instrument inoperative and secure it against any unintended operation.
- Do not operate the instrument in the presence of flammable gasses or fumes. Operation of any electrical instrument in such an environment constitutes a definite safety hazard.
- Do not install substitute parts or perform any unauthorized modification to the instrument.
- Capacitors inside the instrument may retain a charge even if the instrument is disconnected from its source of supply.
- Use caution when exposing or handling the CRT. Handling or replacing the CRT shall be done only by qualified maintenance personnel.

#### Safety Symbols



Instruction manual symbol: the product is marked with this symbol when it is necessary for you to refer to the instruction manual in order to protect against damage to the product.



Hazardous voltage symbol.



Earth terminal symbol: Used to indicate a circuit common connected to grounded chassis.

#### WARNING

The Warning sign denotes a hazard. It calls attention to a procedure, practice, or the like, which, if not correctly performed or adhered to, could result in personal injury. Do not proceed beyond a Warning sign until the indicated conditions are fully understood and met.

#### CAUTION

The Caution sign denotes a hazard. It calls attention to an operating procedure, practice, or the like, which, if not correctly performed or adhered to, could result in damage to or destruction of part or all of the product. Do not proceed beyond a Caution symbol until the indicated conditions are fully understood or met.



---

**Product Warranty**

This Hewlett-Packard product has a warranty against defects in material and workmanship for a period of one year from date of shipment. During the warranty period, Hewlett-Packard Company will, at its option, either repair or replace products that prove to be defective. For warranty service or repair, this product must be returned to a service facility designated by Hewlett-Packard.

For products returned to Hewlett-Packard for warranty service, the Buyer shall prepay shipping charges to Hewlett-Packard and Hewlett-Packard shall pay shipping charges to return the product to the Buyer. However, the Buyer shall pay all shipping charges, duties, and taxes for products returned to Hewlett-Packard from another country.

Hewlett-Packard warrants that its software and firmware are designated by Hewlett-Packard for use with an instrument which execute its programming instructions when properly installed on that instrument. Hewlett-Packard does not warrant that the operation of the instrument software, or firmware will be uninterrupted or error free.

**Limitation of Warranty**

The foregoing warranty shall not apply to defects resulting from improper or inadequate maintenance by the Buyer, Buyer-supplied software or interfacing, unauthorized modification or misuse, operation outside of the environmental specifications for the product, or in proper site preparation or maintenance.

No other warranty is expressed or implied. Hewlett-Packard specifically

disclaims the implied warranties of merchantability and fitness for a particular purpose.

**Exclusive Remedies**

The remedies provided herein are the buyer's sole and exclusive remedies. Hewlett-Packard shall not be liable for any direct, indirect, special, incidental, or consequential damages, whether based on contract, tort, or any other legal theory.

**Assistance**

Product maintenance agreements and other customer assistance agreements are available for Hewlett-Packard products. For any assistance, contact your nearest Hewlett-Packard Sales Office.

**Certification**

Hewlett-Packard Company certifies that this product meets its published specifications at the time of shipment from the factory. Hewlett-Packard further certifies that its calibration measurements are traceable to the United States National Institute of Standards and Technology, to the extent allowed by the Institute's calibration facility, and to the calibration facilities of other International Standards Organization members.

**About this edition**

This is the first edition of the HP 16500B Logic Analysis System User's Reference Guide

Publication number  
16500-97010

Printed in USA.

Edition dates are as follows:  
First edition, April 1994

New editions are complete revisions of the manual. Update packages, which are issued between editions, contain additional and replacement pages to be merged into the manual by you. The dates on the title page change only when a new edition is published.

A software or firmware code may be printed before the date. This code indicates the version level of the software or firmware of this product at the time the manual or update was issued. Many product updates do not require manual changes; and, conversely, manual corrections may be done without accompanying product changes. Therefore, do not expect a one-to-one correspondence between product updates and manual updates.

The following list of pages gives the date of the current edition and of any changed pages to that edition.

All pages original edition



---

Using the Optional  
Keyboard and  
Mouse

---

# The Keyboard and Mouse

This chapter explains how to use the optional keyboard interface (HP E 2427A Keyboard Kit) and optional mouse. The keyboard and mouse can be used interchangeably with the knob and touchscreen for all menu applications. The keyboard and mouse functions fall into the two basic categories of cursor movement and data entry.

Both the keyboard and mouse can be connected to the keyboard/mouse connector on the front panel. If both are connected at the same time, the keyboard is connected to the front-panel connector and the mouse is then connected to the keyboard.

When the keyboard and/or mouse are connected, a graphic is included in the System Configuration menu to represent the interface options being used.

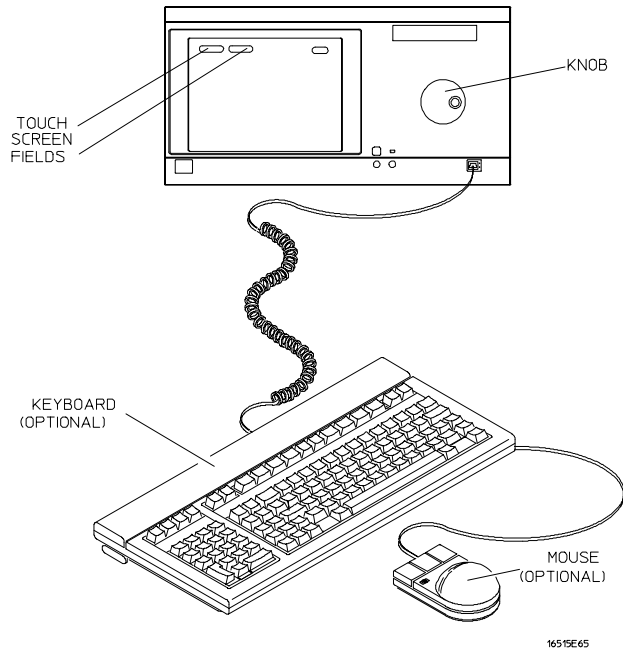

## Keyboard and Mouse



---

## Moving the Cursor

The keyboard cursor is the location on the screen highlighted in inverse video. The mouse pointer appears as a "+" (plus sign). To move the cursor, and pointer, follow one of the methods described below.

### **Keyboard Cursor Movement**

There are four cursor keys marked with arrows on the keyboard. These keys perform the following movements:

- Up-pointing arrow - moves the cursor up.
- Down-pointing arrow - moves the cursor down.
- Right-pointing arrow - moves the cursor to the right.
- Left-pointing arrow - moves the cursor to the left.

The cursor keys do not wrap. This means that pressing the right-pointing arrow when the cursor is already at the rightmost point in a menu will have no effect. The cursor keys do repeat, so holding the key down is the fastest way to continue keyboard cursor movement in a given direction.

You can also use the cursor keys to duplicate the function of the knob on the front panel of the HP 16500B. To simulate rotating the knob clockwise, simultaneously press the **Shift** key and either the up-pointing arrow key or the right-pointing arrow key. To simulate rotating the knob counter-clockwise, simultaneously press the **Shift** key and either the down-pointing arrow key or the left-pointing arrow key.

**Tab Key** Another way to move the keyboard cursor is to use the Tab key. The Tab key wraps and repeats. You can scroll through all the choices in a given menu by pressing and holding down the **Tab** key. The Tab key moves the keyboard cursor from left to right, and, upon reaching the right margin of a line, causes the cursor to move to the left margin of the next line and continue its left-to-right motion.

If you want to want to move in the opposite direction, from right to left, moving up to the next higher line when the left margin is reached, press and hold both the **Tab** key and the **Shift** key simultaneously.

It should be noted that neither the Tab key nor the Tab and Shift key combination will work in scroll-type pop-up menus. Use the cursor keys to make selections in these menus.

**Home Key** If you want to move the cursor to the first item in a menu, press the **Home** key. If you want to move the cursor to the last item in a menu, press the **Home** and **Shift** keys simultaneously.

**Next and Previous Keys** The Next and Previous keys are used for paging through listings. The Next key will display the next page of data, if one exists. The Previous key will display the previous page of data, if one exists. These functions work only for the logic analyzer modules.

**Selecting a Menu Item** To select a menu item using the optional keyboard, position the cursor on the desired menu item using one of the methods described in the section "Moving the Cursor" and press either the **Return** or the **Select** key.

#### **Mouse Pointer Movement**

The mouse pointer (+) is positioned around the screen by moving the mouse about the top of the desk or mouse pad.

**Selecting a Menu Item** To select a menu field, simply move the pointer on top of the desired field and press the upper-left button.

To duplicate the front-panel knob, hold down the center button while moving the mouse around the desktop. Moving the mouse up or to the right duplicates turning the knob clockwise. Moving the mouse down or to the left duplicates turning the knob counterclockwise.



---

## Entering Data into a Menu

### **Keyboard Data Entry**

When the cursor is over the desired field, and either the Return key or the Select key is pressed, the cursor is displayed over the leftmost digit of the particular item. When you enter a number, it is displayed in the cursor position, and the cursor is advanced. Cursor keys move the cursor within the field. Pressing either the **Return** key or the **Enter** key will terminate data entry for that item.

If you want to erase the data entry, press the **Clear Line** key, the **Clear Display** key, or the **Delete Line** key.

### **Mouse Data Entry**

When an assignment field is selected with the mouse, a pop-up keypad or an assignment pop-up appears. Use the pop-up menus to assign letters, numbers, symbols, or units of measure. When the **Done** field is selected, the pop-up menus close and the values are entered into the assignment field.

### **Autoroll**

When entering pattern generator data, you can move through each line horizontally, filling in each data field in the line before going to the next line, or you may want to fill in all the data in a column before moving on to the next column. The Autoroll feature makes moving from one data entry field to another easier than selecting each in succession.

When you select a data field and the pop-up appears, notice that a field labeled Autoroll also appears at the left side of the screen. To use the Autoroll feature, place the cursor over the desired data field, then press either the Return key or the Select key. When the cursor is at the left margin of the data, press the left-pointing arrow key. The cursor will disappear from the data and reappear in the Autoroll field.

When you select the Autoroll field, another pop-up appears. This pop-up presents you with three choices:

- Off.
- A field containing a right-pointing arrow and a down-pointing arrow.
- A field containing a down-pointing arrow.

If you want to move through your data line by line, from left to right, select the field marked with the right-pointing arrow and the down-pointing arrow. Once this field is activated, the pop-up will close and autoroll through the data fields from left to right. When you finish entering data into the last field in a line, the pattern generator will automatically move to the first field in the next line. This process continues until the pattern generator reaches the end of the program or until you turn the Autoroll off.

If you want to move through your data column by column, select the pop-up field marked with the down-pointing arrow. When this field is selected, the pattern generator moves down each column of data, and, when data entry in the column is complete, automatically moves to the top of the next column. This process continues until the end of the program is reached or until you turn the Autoroll off.

Autoroll is automatically turned off when data entry to all the available fields is complete. If you want to turn off the Autoroll before data has been entered into all the data fields, press the left-pointing arrow key when the cursor is at the left margin of a data field. When the Autoroll pop-up appears, select Off.

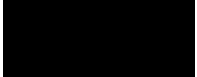

## Using the Keyboard Overlays

The function keys above the number pad have been redefined to work with the HP 16500B/16501A keypad. Two keyboard overlays are included in the HP E 2427A Keyboard Kit. The overlays show the redefined function and number pad keys. These function keys are listed below.

### Units and Hex Keys

Key	Real-Time Keypad	Voltage Keypad	Hex Keypad
F9	Seconds	Volts	D
F10	Milliseconds	Millivolts	E
F11	Microseconds	-	F
F12	Nanoseconds	-	-
*	-	-	A
/	-	-	B
+	-	-	C

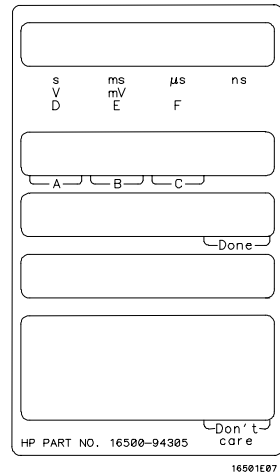
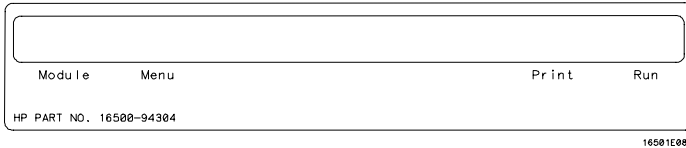

### Keyboard Overlays



### Don't Care Key

Tab is the "Don't Care" key. The value of this key is determined by the currently displayed keypad. It is "X" in the hex keypad and double quotes (") in the stimulus hex keypad.

---

### Don't Care Key

---

Key	Stimulus Hex Keypad	Hex Keypad
Tab ("Don't Care")	Double Quotes (")	X

### Function Keys

Several function keys have been provided to simplify frequently used keystrokes. The function-to-key mapping is shown below.

It should be noted that F1, F2, F7, and F8 only work when there are no submenus popped up.

---

### Function Keys

---

Key	Function
F1	Selects and pops up the module field.
F2	Selects and pops up the menu field.
F7	Selects and pops up the print field.
F8	Invokes the run key for its current setting. If the run key is set to repetitive, then pressing F8 will invoke repetitive running. If the run key is set to single run, then pressing F8 will invoke a single run. If the module is running, then F8 will stop the module.

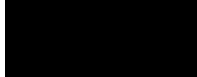

---

## Defining Time Units

In addition to the function keys which are mapped to the HP 16500B/16501A real-time keypad, other keys on the keyboard invoke the units keys. The time unit keys are listed below.

---

### Time Units Keys

---

Key	Time Units
S	Selects the seconds units
M	Selects the milliseconds units
U	Selects the microseconds units
N	Selects the nanoseconds units

---

## Defining Voltage Units

Besides the function keys which are mapped to the HP 16500B/16501A real-time keypad and the time units keys, other keys on the keyboard invoke the voltage units keys. The voltage unit keys are listed below.

---

### Voltage Units Keys

---

Key	Voltage Units
V	Selects volts
M	Selects millivolts

---

## Assigning Edge Triggers

Several keys map to edge assignments. These keys and their functions are listed below.

---

### Edge Trigger Keys

---

<b>Key</b>	<b>Edge Trigger Assignment</b>
U	Selects the up or rising edge.
D	Selects the down or falling edge.
R	Selects the rising edge.
F	Selects the falling edge.
B	Selects either the rising or falling edge.
Up-Pointing Arrow	Selects the rising edge.
Down-Pointing Arrow	Selects the falling edge.

---

## Closing a Menu

To exit a menu, press either the Done or Enter key. The Enter key is mapped to the Done key, so pressing either key closes the menu.



---

## Connecting the Keyboard and Mouse

To connect either the keyboard or the mouse into the front-panel connector, simply match the plug and front-panel connector keys, then push in the plug as shown below.

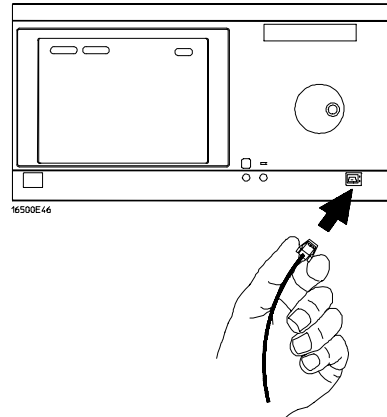

### Inserting Keyboard or Mouse Plug

#### To Disconnect Keyboard or Mouse

To disconnect the keyboard or mouse plug from the front-panel connector, press the two spring clips on the plug end together and gently pull the plug out.

Using the Optional Keyboard and Mouse  
**Connecting the Keyboard and Mouse**

**Connecting Both the Keyboard and Mouse**

To connect both the keyboard and mouse together, chain them together as shown below.

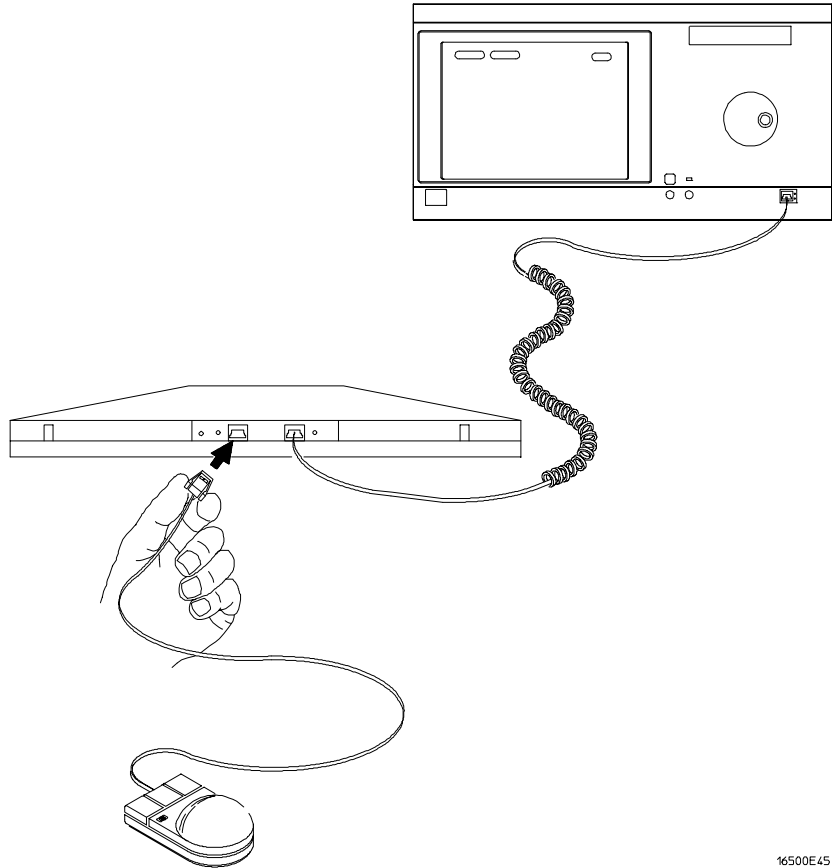

16500E45

**Connecting Both Keyboard and Mouse to Front-Panel**



---

The Optional  
HP 16501A  
Expansion Frame

---

## The HP 16501A Expansion Frame

The HP 16501A Expansion Frame has been developed to extend the HP 16500B Logic Analysis System beyond its present five-card limit and meet the anticipated need for systems requiring more than five slots.

This chapter explains the features, components, and system configuration of the HP 16501A. There are sections explaining and illustrating module-to-module system arm ing and triggering, as well as an inter-frame arm ing/triggering block diagram. In addition, this chapter contains information on how to connect the HP 16501A to the HP 16500B.

Adding the HP 16501A to the HP 16500B creates a tightly coupled two frame, ten-card system fully controlled by the HP 16500B. A single power switch (located on the HP 16500B front panel) turns on both frames.

The HP 16501A offers inter-frame module arm ing/triggering capabilities with a 2 nanosecond time correlation between modules.

---

## Component Details

The HP 16501A Expansion Frame is very similar to the mainframe. It consists of a card cage, rear panel, power supply, and fans. Included with the HP 16501A is an interface board which enable you to connect the HP 16501A to the HP 16500B. This interface board (the HP 16500L), may be deleted from your order if you already have one installed in the HP 16500B mainframe.

### **The HP 16500L Interface Board**

The HP 16500L interface board is installed in the mainframe. It contains circuitry for several important functions, one of which is to interface the mainframe to the HP 16501A expansion frame. The interface is a buffering scheme to pass signals between the mainframe and the HP 16501A back plane. It contains circuitry which controls external timing selection and enables an HP 16501A card to drive an output dedicated to triggering other instruments.

In addition to acting as an interface for the expansion frame, the HP 16500L is also required if you want to connect the HP 16500B to a LAN or if you want to use video outputs to display screens on other monitors. As mentioned above, if you already purchased the interface board for one of these other purposes, you can delete the HP 16500L option from the HP 16501A Expansion Frame order.

### **See Also**

The documentation that comes with the HP 16500L for complete information on its installation, options, and operation.



---

## System Configuration

The expansion frame interface board is connected to the main frame interface board through a 68-pin flat cable as shown below. In addition to the HP 16500B rear panel signals, the cable incorporates control signals which allow the CPU to communicate with and control the expansion frame interface board. Ground lines separate signal lines within the cable to prevent cross-coupling or soft failures. The cable is externally shielded to reduce RFI emissions.

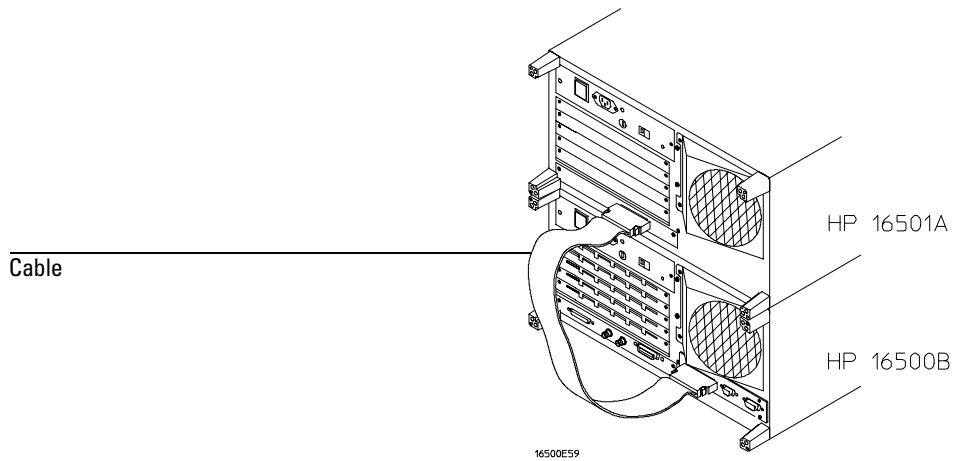

### Connecting Cable

---

## System Arm ing and Triggering

Module-to-module arm ing within the HP 16501A follows the arm ing specifications for the HP 16500B in that any module may arm any other module. The maximum intermodule arm ing level is five.

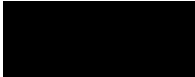

When the HP 16501A is attached to the HP 16500B, the resulting HP 16500B/16501A system operates as a single frame. The HP 16500B and HP 16501A may receive only one external arming signal from the other frame. The figure below shows how module-to-module arming is selected.

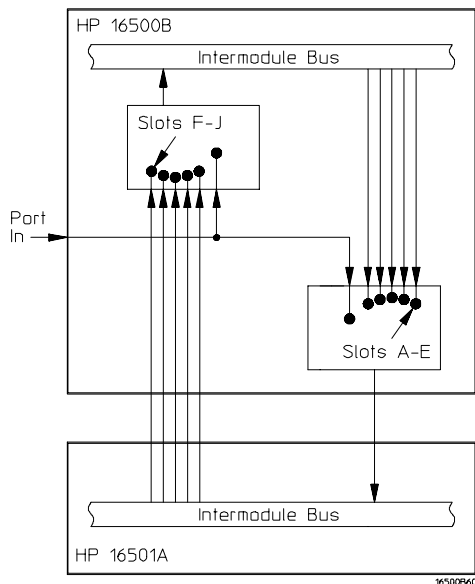

### Module to Module Arming

The HP 16500B main frame may use only two external arming signals: any module in the HP 16501A expansion main frame or the rear-panel BNC. The arming signal can come from three sources:

- Any module in the HP 16500B main frame.
- Any module in the HP 16501A expansion main frame.
- From the rear-panel Port In BNC.

The arming signal from the HP 16501A overlays with the PORT-IN signal. If a measurement requires that modules in the 16500B receive arming signals from both PORT-IN and the HP 16501A, the modules should be reconfigured. Arrange the modules such that PORT-IN arms the module in the HP 16500B and the module in the HP 16501A arms the module in the HP 16501A.

## The Optional HP 16501A Expansion Frame System Arming and Triggering

Any card in the HP 16500B mainframe can be armed from its external inputs or from one of the other four cards in the HP 16500B mainframe.

The HP 16501A expansion mainframe may use only one external arming signal. The arming signal for any module can come from two sources:

- Any module in the HP 16501A expansion mainframe.
- From a single module or the Port In BNC in the HP 16500B mainframe.

Any module in the HP 16501A expansion mainframe may be armed from a single HP 16500B module or from one of the other four modules in the HP 16501A expansion mainframe.

To summarize, the arming triggers available for output from the HP 16500B/16501A are:

### HP 16500B

- -Module A through Module E.
- -Port In BNC.

### HP 16501A

- -Module F through Module J.

It should be noted that only the HP 16500B has a Port Out BNC. There is no Port Out BNC on the HP 16501A. The Port Out signals from module F through module J use the Port Out BNC on the HP 16500B.

### See Also

The "Intermodule Measurements" chapter found earlier in this User's Reference Guide for more information on intermodule measurements using the HP 16500B/16501A.

---

## Connecting the HP 16501A Expansion Frame

The optional HP 16501A Expansion Frame has two components:

- The expansion frame.
- A flat, bidirectional cable 2 meters long with a 68-pin "D" connector at each end.

Connect the HP 16501A to the HP 16500B as illustrated below.

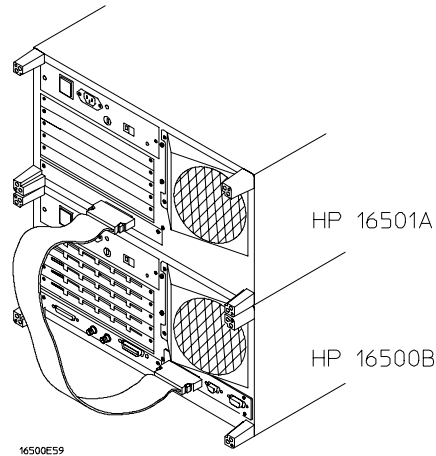

### Connecting the Optional Expansion Frame

Make sure the connector is properly seated into the port by pulling the connector without pressing the release tabs. If the connector is properly seated it will remain connected to the port.

At power-up, the HP 16500B CPU board checks for an expansion frame connection. If found, the CPU establishes a "link" between the rear panels of the two frames. The interface link is graphically displayed by the System Configuration menu.





Labels Assignment

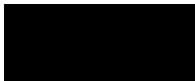

# Labels

Hewlett-Packard logic analyzers give you the ability to separate or group data channels and label them with a name that is meaningful to your measurement. The information in this chapter is applicable to all analyzers.

Labels are assigned only in the Format menu. Once assigned, the labels are displayed in all display menus. Use labels when you want to group data channels by function with a name that has meaning to that function.

The default label names are Lab1 through Lab126. However, the names can be modified to any six character string. The figure below gives you an example of label use.

The screenshot shows the 'Format 1' menu of a logic analyzer. At the top, there are buttons for 'Print' and 'Run'. Below that, there are settings for 'State Acquisition Mode' (Full Channel/4K Memory/100MHz), 'Master Clock' (J↑), 'Slave Clock' (K↓), and 'Symbols'. There are also 'Clock Inputs' and 'Pod' settings (Pod A2, TTL, Pod A1, TTL, Master Clock, Slave Clock). A 'Labels' section is highlighted with a '+' sign. Below this, a table shows assigned labels and default labels.

Label Name	Channel 1	Channel 2	Channel 3	Channel 4
DATA	..	.....*****	.....	.....
ADDR	..	.....	.....*****	.....
Lab3				
Lab4				
Lab5				
Lab6				
Lab7				
Lab8				

Annotations on the left side of the image:

- 'Assigned labels' points to the 'DATA' and 'ADDR' rows in the table.
- 'Default labels' points to the 'Lab3' through 'Lab8' rows in the table.

**Labels in the Format Menu**

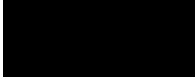

---

## Label Assignment Fields

The label assignment fields found in the Format menu display the user-defined label names. Custom label names are used when there are different types of data which must be tracked. The labels you assign in the Format menu will appear in all other display menus. Labels can be added or deleted in other display menus, but not assigned. Label assignment can only be done in the Format menu.

The label column contains 126 label fields that you can define. The analyzer displays only 8 labels at any time.

When any label field is selected, a pop-up menu appears which is used to modify the label list.

Label assignment field

The screenshot shows a software interface for configuring an analyzer. At the top, there are buttons for '100/500MHz LA B', 'Format 1', 'Print', and 'Run'. Below these are settings for 'State Acquisition Mode' (Full Channel/4K Memory/100MHz) and 'Master Clock' (Jf), with a 'Symbols' button. The interface is divided into three sections for 'Pod B3', 'Pod B2', and 'Pod B1', each with 'TTL' and 'Master Clock' options. A 'Labels' section at the bottom shows a list of 8 labels (Lab1 to Lab8) and a '+' button for adding new labels. The 'Labels' section also displays some numerical data and asterisks.

### Label Fields



## Labels Assignment Label Assignment Fields

### Turn Label On

The Turn Label On selection is used to activate a label and its accompanying bit assignment field. Once a label field is activated, a custom name can be assigned. If a custom name is not assigned, the default name assigned by the analyzer will remain the label. In addition, if no channels are turned on in the bit assignment fields, the label is turned off when the Format menu is exited.

### Turn Label Off

The Turn Label Off option turns off the label. When a label is turned off, the label name and the bit assignments are saved by the logic analyzer. This gives you the option of turning the label back on and still having the bit assignments and name if you need them. With labels off, the label names remain displayed for identification and searching purposes.

### Modify Label

If you want to change the name of a label, or want to turn on a label and give it a specific name, you would select the Modify Label option. When selected, an alpha-numeric entry pop-up appears for you to enter a label name. A label name can be a maximum of six characters.

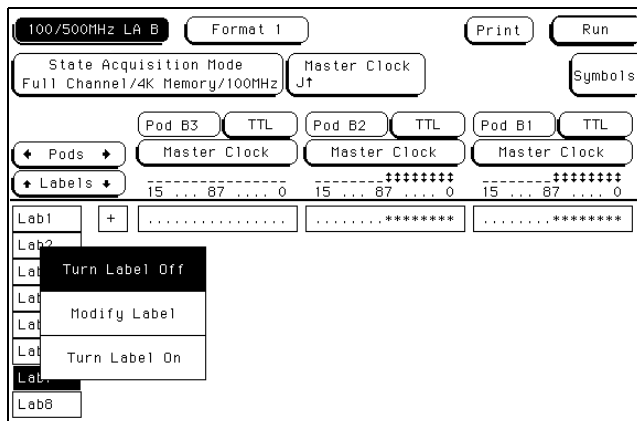

### Modify Label Selection Pop-up

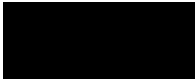

---

## Rolling Labels and Pods

The Labels rolling field allows you to view offscreen labels.

To view offscreen labels, select the Labels roll field to ensure it is a light blue is active, then rotate the knob. The labels scroll up and down.

The Pods rolling field allows you to view offscreen pods.

To view offscreen pods, select the Pods roll field to ensure it is active, then rotate the knob. Pods are positioned with the lowest numbered pod on the right.

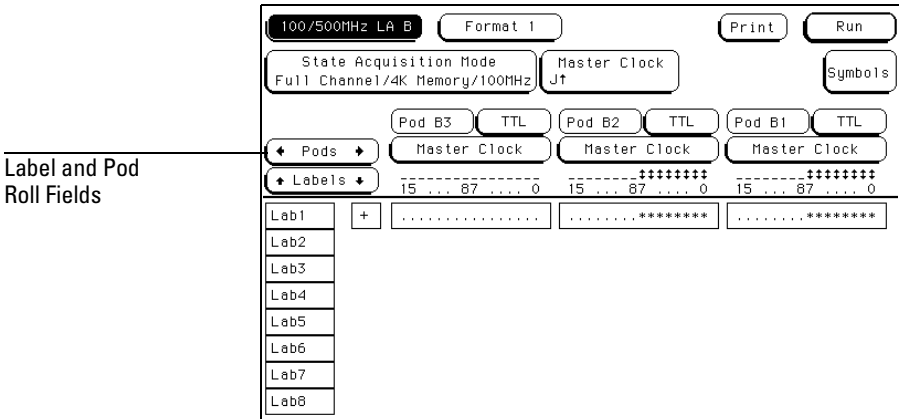

**Labels and Pods Roll Fields**





Sym bols  
Assignm ent

# Symbols

State listings can display acquired data in a variety of numeric formats. However, one of the most useful forms of display is not a numeric form, but a symbolic form.

When symbols are defined and the base type set to Symbols, the custom mnemonic you create is placed in the data listing where the bit pattern would normally be displayed. This makes the data listing easy to read or scan for specific.

You can specify up to 1000 symbols within an analyzer module. If your analyzer module can be configured into two analyzer types (state and timing), you can use all 1000 symbols in one analyzer type or divide them between both.

The screenshot shows a software interface with a menu bar at the top containing '4GHz/1GHz LAB', 'Listing', 'Acq. Control', 'Print', and 'Run'. Below the menu bar are several buttons: 'Markers Pattern', 'Find X-pattern', a button with '1', 'from Trigger', and 'Specify Patterns'. The main display area contains a table with columns for 'Label>', 'DATA', and 'Time'. Below the table, there are sub-columns for 'Base>', 'Symbol', and 'Absolute'. The table lists 17 rows of data, with the 9th row highlighted. A horizontal line labeled 'Symbols' on the left points to the 'Symbol' column.

Label>	DATA	Time
Base>	Symbol	Absolute
2	START-SUB-1	512.0 ns
3	STEP-S1 +00	768.0 ns
4	STEP-S1 +02	1.024 us
5	STEP-S1 +03	1.280 us
6	END-SUB-1	1.536 us
7	INTERUPT-3	1.792 us
8	MEM-CHK +00	2.048 us
9	MEM-CHK +01	2.304 us
10	MEM-CHK +02	2.560 us
11	MEM-CHK +04	2.816 us
12	MEM-CHK +05	3.072 us
13	MEM-CHK +06	3.328 us
14	MEM-CHK +07	3.584 us
15	MEM-CHK +09	3.840 us
16	MEM-CHK +0A	4.096 us
17	MEM-CHK +0B	4.352 us

Example of Symbols in a Data Listing

---

## Symbols Field

The Symbols field is located in the Format menu and is used to access the symbols table. The symbols table is where all symbols are created and maintained. The figure below shows the Symbols field in a state analyzer's Format menu.

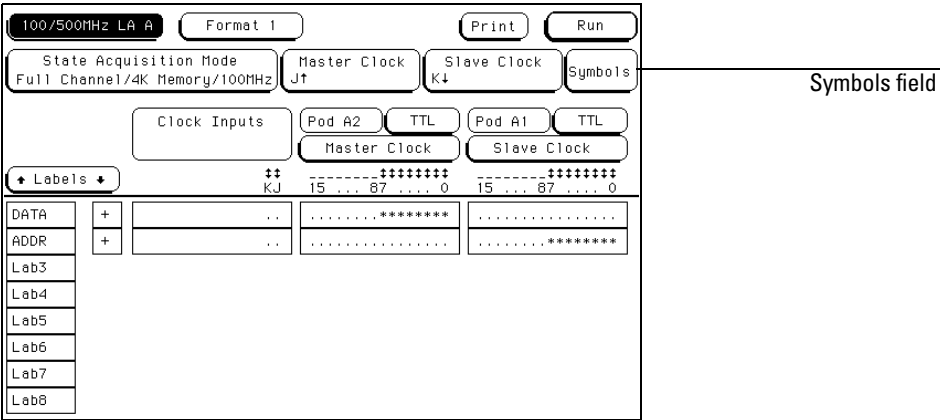

**Symbols Field in the Format Menu**

## Symbols Assignment Symbols Field

Symbol	Type	Pattern/Start	Stop
START-SUB-1	pattern	01	
STEP-S1	range	02	05
END-SUB-1	pattern	06	
INTERUPT-3	pattern	08	
MEN-CHK	range	09	FF

### Symbols Table Pop-up Menu

#### Label Field

The Label field identifies the label for which you are specifying symbols. When you select this field, a selection menu appears that lists all the labels turned on for that analyzer. Each label has a separate symbol table so you can give the same name to symbols defined under different labels. From the label selection menu, select the label for which you wish to specify symbols.

#### Base Field

The Base field is used to select the numeric base in which the pattern in the symbols menu is displayed. If more than 20 channels are assigned to a label, the Binary option is not offered. As a result, when a symbol is specified as a range, there is only enough room for 20 bits to be displayed on the screen. Decide which base you want to work in and choose that option from the numeric base pop-up menu.

If you choose the ASCII option, you can see what ASCII characters the patterns and ranges defined by your symbols represent. ASCII characters represented by the decimal numbers 0 to 127 (hex 00 to 7F) are offered on your logic analyzer.

You cannot specify a pattern or range when the base is ASCII. First define the pattern or range in one of the other bases, then switch to ASCII to see the ASCII characters.



### **Symbol Width Field**

The Symbol Width field is used to specify how many characters of the symbol name will be displayed when the symbol is referenced in the Trigger, Waveform, and Listing menus.

Select the Symbol Width field and set the number of characters in the symbol. You can have the logic analyzer display from 3 to 16 of the characters in the symbol name.

### **Symbol Name Field**

When you first access the symbol table, there are no symbols specified. The symbol name field reads "New symbol". Select this field and enter the name of your symbol. A maximum of 16 characters can be used in a symbol name.

When you select the Done field in the pop-up keypad, the name you specified is assigned and appears in the symbol's name field.

When a symbol name is assigned, the symbol Type field becomes active. The symbol Type field is used to define the symbol type as either a pattern or a range. When you select this field, it toggles between pattern and range.

### **Pattern Type Field**

When the symbol is defined as a pattern, a Pattern/Start field appears to the right of the Type field. Use this field to specify what the pattern is. Select the Pattern/Start field and enter the desired pattern.

### **Range Type Field**

If the symbol is defined as a range, a Pattern/Start field and a Stop field appears. Use these fields to specify the upper and lower boundaries of the range.

Select both fields and specify the boundaries of the range. You can also specify ranges that overlap or are nested within each other.



## Symbols Assignment Symbols Field

To add, delete, or modify symbols in the symbol table, select any field displaying a defined symbol name. A pop-up menu appears with the following choices.

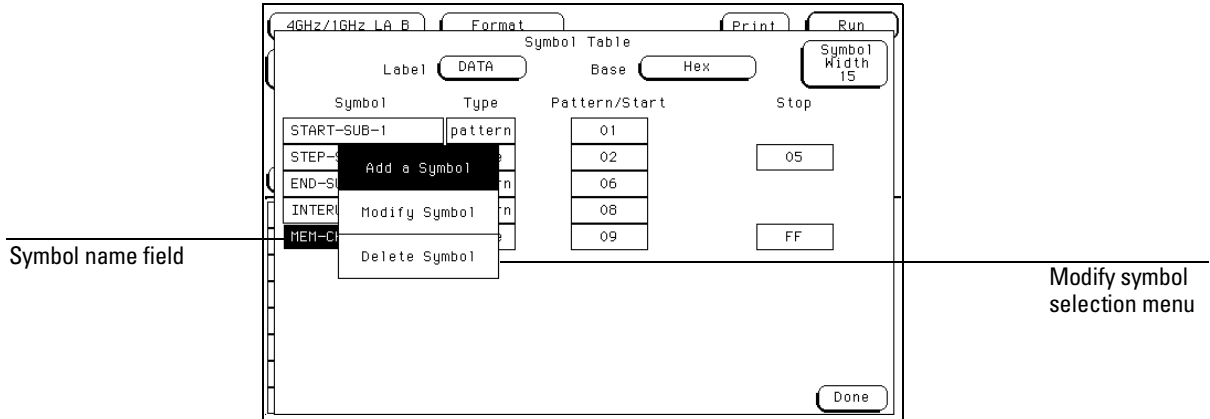

### Modify Symbol Selection Menu

#### Modify Symbol

Select this option to change the name of the symbol.

#### Add a Symbol

When you select this option, you must enter a new symbol name. When you select Done, your new symbol will appear in the symbol table directly below the original symbol name.

#### Delete Symbol

If you select this option, the highlighted symbol will be deleted from the symbol table.

When you have specified all your symbols, you can leave the symbol table menu by selecting the Done field.



---

## Installing and Removing Cards

---

## Installing and Removing Cards

This chapter is organized into two types of information. First, there is a general installation section which contains the procedure to install and remove modules from the main frame. If there is no specific cabling considerations for a single card module, this section is all that is required for installation information.

After the general installation information are sections which contain inter-card cable information for multi-module configurations. You should first refer to these sections to make sure any cables are connected properly, then you can install the module into the main frame.

Because of the modular design of the Logic Analysis System, it allows you to move modules within and between the HP 16500B and the HP 16501A frames. Be sure you check each specific model's calibration considerations for any unique calibration concerns.

### **General Installation Considerations**

- When modules have both a master card and an expansion card, both cards must be installed in the same frame. For example, an HP 16520A master card must be installed in the same frame as the HP 16521A expansion card.
- Do not install, remove, or replace cards unless the instrument is shut off and the power cord is disconnected.
- Filler panels must be installed in all unused card slots to ensure correct air circulation.
- Save all unused cables and filler panels for future configurations

---

# General Installation Procedure

## Where Do Cards Mount?

Turn off the instrument and unplug it. Then turn the frame around so the rear panel is facing you.

Each frame contains five slots in which to insert the cards. Each slot has a label to its right. The top slot on the HP 16500B is A, the next one down is B, then C, D, and E. The CPU board of the frame is located beneath slot E.

The top slot on the HP 16501A is labeled F, the next one down is G, then H, I, and J.

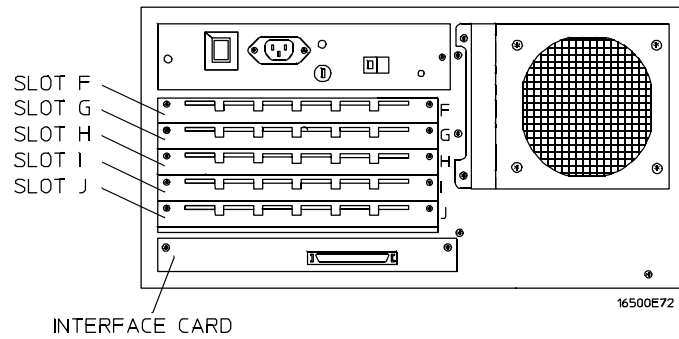
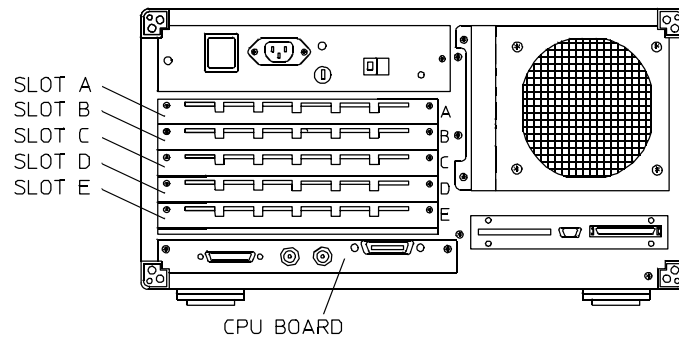

## The HP 16500/16501 Card Cages

**Installing Cards in the HP 16500B /16501A**

**CAUTION**

The effects of ELECTROSTATIC DISCHARGE can damage electronic components. Grounded wriststraps and mats should be used when you perform any kind of service to the mainframe or the cards in it.

- 1 Starting from the top of the card cage, loosen the thumb screws on the filler panel(s) and pull them out of the frame.

Since the endplates of the cards overlap, you must start with the top slot of the frame you want to change and work down when removing cards. To install cards, start with the first open slot at the bottom of the card cage in the frame in which you are changing the cards and work up.

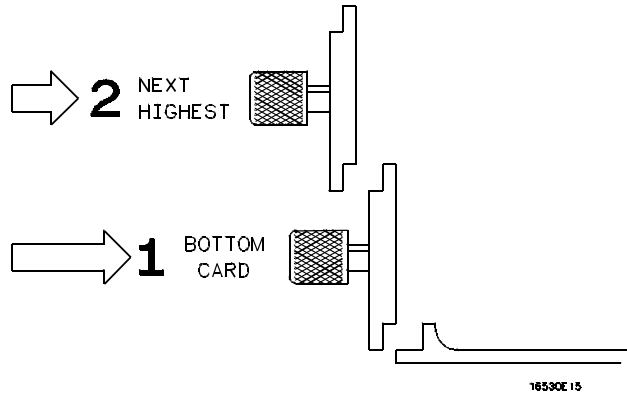

**Endplate Overhang**

- 2 Hold the card (or set of cards) so that the components are facing upward and the main connector is pointing away from you.
- 3 Align the card (or set of cards) with an appropriate set of slots on the rear panel, filling the slots closest to the bottom first. Gently slide the card in until the connector on the card touches the connector on the frame.

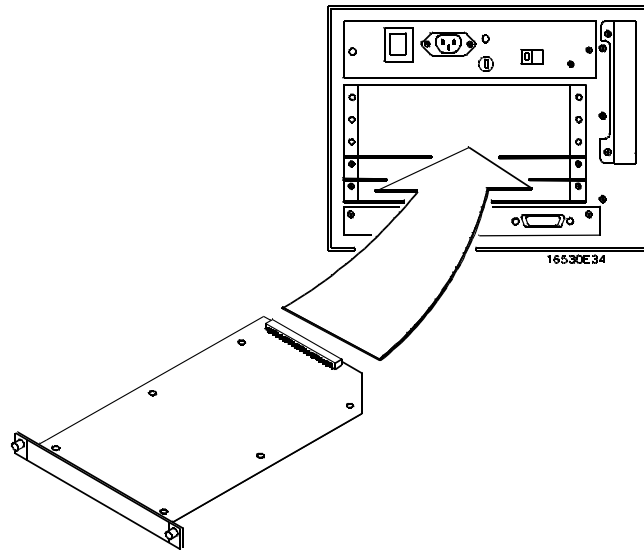

#### Installing Cards

- 4 Gently, but firmly, push the card in until the endplate on the card is flush with the rear panel.
- 5 While applying pressure to the center of the card endplate, tighten down the thumb screws on either side of the endplate.
- 6 After you are finished installing cards, install filler panels in all unused slots.

### Removing Cards from the HP 16500B /16501A

To remove cards from the frame, you must start with the card in the top slot (slot A in the HP 16500B or slot F in the HP 16501A) of the frame in which you are changing cards. Remove the next card down. Proceed in this manner until you get to the card you need. To remove the cards from their slots:

- 1 Loosen the thumb screws on either side of the endplate of the card until the thumb screws are free from the frame. If two cards need to be removed together, loosen the screws from both cards before trying to remove the cards.
- 2 Gently, but firmly, pull on the heads of the thumb screws and slide the cards out.

---

## HP 16532 Installation Considerations

Multi-module oscilloscopes must be configured such that the modules are installed adjacent to one another, with no empty slots between them and no other test and measurement modules between them. The top-most module in a multi-module configuration automatically becomes the master card.

After a module has been installed, it is recommended that each oscilloscope module contained in the multi-module configuration be calibrated. In some cases all of the modules in the mainframe must be calibrated. Refer to the applicable manual for calibration requirements for any other modules that may require calibration.

Each oscilloscope module is shipped with a cable that is used to make the module-to-module connection required for multi-module operation. The master-to-slave Trigger Cable is about three inches long with right angle SMB connectors on both ends. Multi-module oscilloscope configurations are made up of identical HP 16532 modules. All modules in a multi-module oscilloscope are identical (and interchangeable). In multi-module oscilloscope operation, it is convenient to refer to a "master" card and "expansion" cards, but remember that physically these are identical modules. Each oscilloscope module has a pair of SMB connectors on the rear panel. These connection ports are designated ECL EXT TRIG IN and ECL EXT TRIG OUT. By making the appropriate connections between these ports, multiple stand alone, 2 channel oscilloscopes can be configured as a single multi-channel oscilloscope.



There are several rules that you must understand and follow to configure multiple oscilloscope modules as a single multi-channel oscilloscope.

- HP 16532 module configurations are determined at system power up. Changes (adding or removing interconnect cables) to the configuration will not be recognized by the system unless the AC power is cycled.
- In a multi-module HP 16532, the top-most module is the "master" module (master card). The master card slot letter will be used to identify this multi-module oscilloscope in various mainframe operations.
- The modules making up a multi-module oscilloscope must be located in adjacent card slots.
- A multi-module oscilloscope must reside entirely within the cardcage of either the HP 16500B Mainframe or the HP 16501A Expansion Frame.
- The interconnecting cable must run from the "ECL EXT TRIG OUT" port of the master card (top-most module in the oscilloscope configuration) to the "ECL EXT TRIG IN" port of the first expansion module (module located adjacent to and below the master card).
- Connect additional expansion modules in a similar manner (that is, from the "ECL EXT TRIG OUT" port of the upper expansion module to the "ECL EXT TRIG IN" port of the next lower expansion module).
- If more than four HP 16532 modules are connected together, they will power up as a four-module oscilloscope (top four modules) and a one-module oscilloscope.
- Connections to the "ECL EXT TRIG IN" port on the master card are ignored at power up.

**Multimodule Installation Procedure**

- 1 Turn instrument power switch off, unplug power cord and disconnect any input connections.
- 2 Insert or remove measurement modules as needed to position modules in desired card slots. Use the procedures given in the section titled "General Installation Procedure" given earlier in this chapter.
- 3 Install the interconnecting cable, or cables, between the HP 16532 modules. See the following figure. Follow the configuration guidelines given in the "HP 16532A Installation Considerations" section.

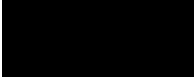

**Multimodule Oscilloscope**

HP 16500B LOGIC ANALYSIS SYSTEM

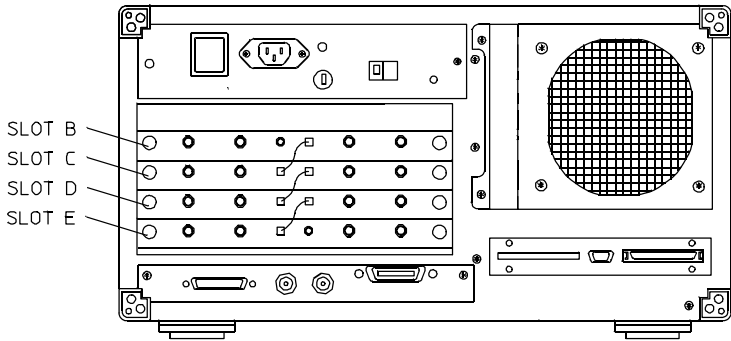

HP 16501A LOGIC ANALYSIS SYSTEM  
EXPANDER FRAME

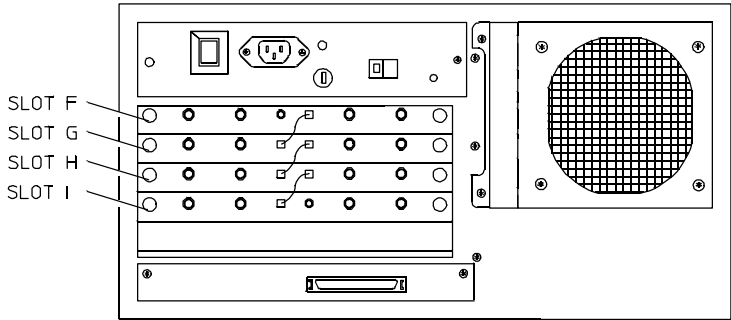

16500E71

- 4 Install flexible disks with appropriate software and turn on AC power to the mainframe.

If the system power up configuration screen does not display the expected combination of oscilloscope master and expansion cards, check the cable connections and recycle power.

Adjacent HP 16532 modules will be treated as stand alone 2 channel oscilloscope modules at power up if they are not cabled together.

The HP 16517A module can be used as a one-card module. The HP 16518A module can not be used as a one-card module.

If you need to configure a multichannel module into a one-card module, simply remove the cables connecting the cards.

---

### To configure a multichannel module

To configure a multichannel module, connect the cables as follows. Use the figure at on page 3-12 as a guide.

Save unused cables for future configurations.

- To configure a two-card module, use the short cable to connect the HP 16517A Master Card to the HP 16518A Expansion Card. Any of the two-card configurations shown in the illustration on page 3-12 can be used. The Master Card can be above or below the Expansion Card. Note that if the Master Card is below, the connector on the left side of the Master Card (when looking at back of main frame) must be used; when the Master Card is above the Expansion Card, the connector on the right side of the Master card must be used.
- To configure a three-card module, you can have the Master Card in between the Expansion Cards, or above or below the Expansion cards (see illustration on page 3-12). Note the cables which are used for each configuration, and the side of the Master Card which is used for connecting. If the Master Card is below, the connector on the left side of the Master Card (when looking at back of main frame) must be used; when the Master Card is above the Expansion Card, the connector on the right side of the Master card must be used.

## Installing and Removing Cards

### To configure a multcard module

- To configure a four-card module, you can have one Expansion Card above the Master Card and two below, or two Expansion Cards above and one below (see illustration below). Note the cables which are used for each configuration, and the side of the Master Card which is used for connecting. If the Master Card is below the Expansion Card, the connector on the left side of the Master Card (when looking at back of main frame) must be used; when the Master Card is above the Expansion Card, the connector on the right side of the Master Card must be used.
- To configure a five-card module, the Master Card must go in the middle slot, and two Expansions Cards are above it and two are below it (see illustration below). The two long cables (three connectors) must be used. For the Expansion Cards above the Master Card, use the connector on the left side of the Master Card (when looking at back of main frame); for the Expansion Cards below the Master Card, the connector on the right side of the Master Card must be used.

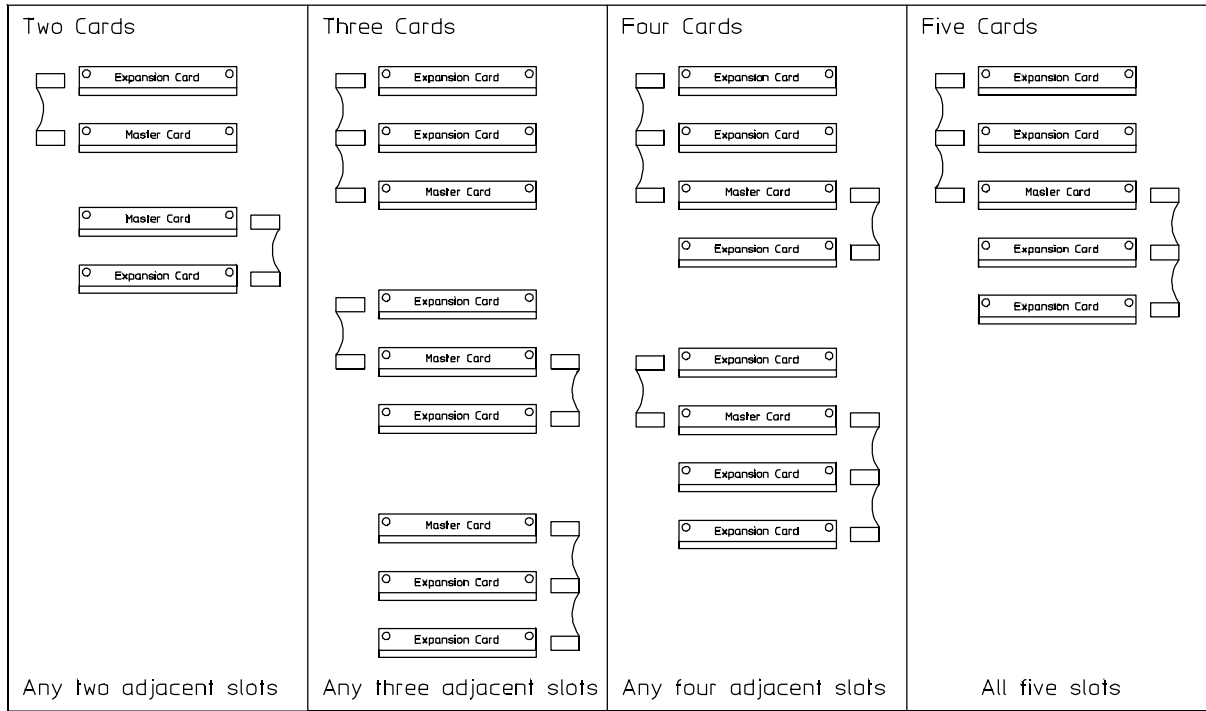

16517M01