

To ensure proper electrical and thermal performance there must be a ground plane with 100% solder connection underneath the part

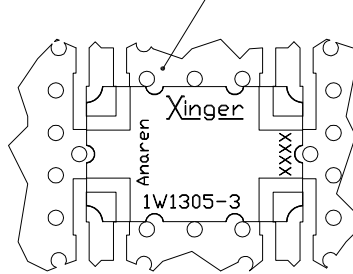

Part Is Symmetric About All Axis

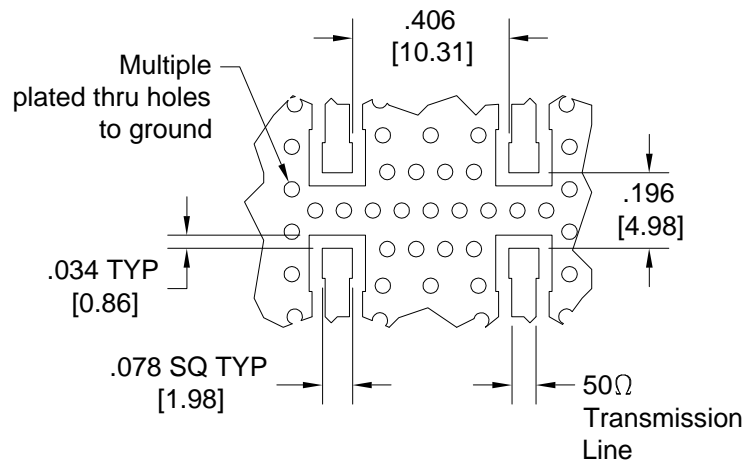

Dimensions are in Inches [Millimeters]
1W1305-3 Rev A Mounting Footprint