

To ensure proper electrical and thermal performance
there must be a ground plane with 100%
solder connection underneath the part

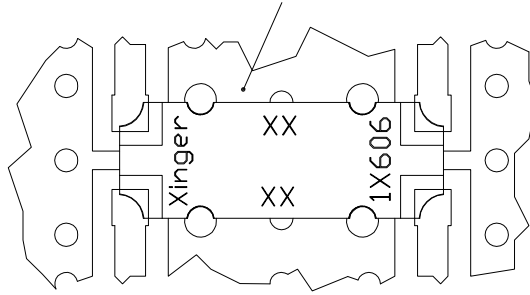

Part Is Symmetric About All Axis

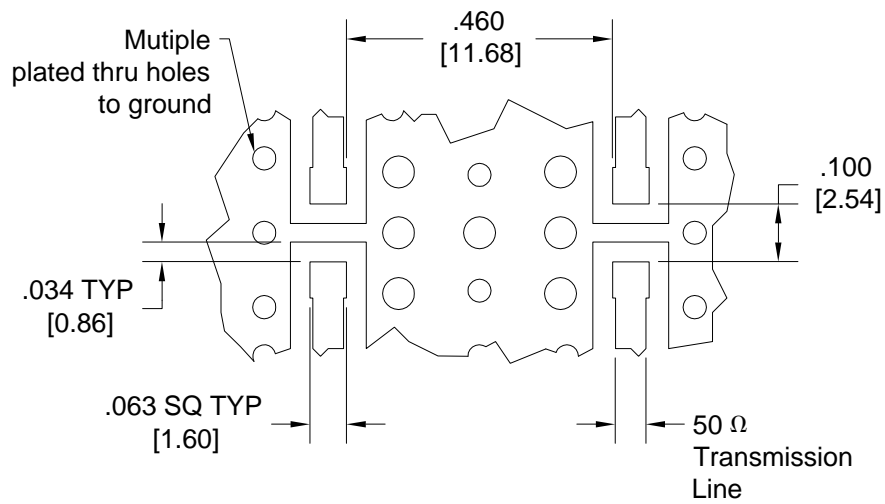

Dimensions are in Inches [Millimeters]
1X606 Rev A Mounting Footprint