

Top View (Near-side)

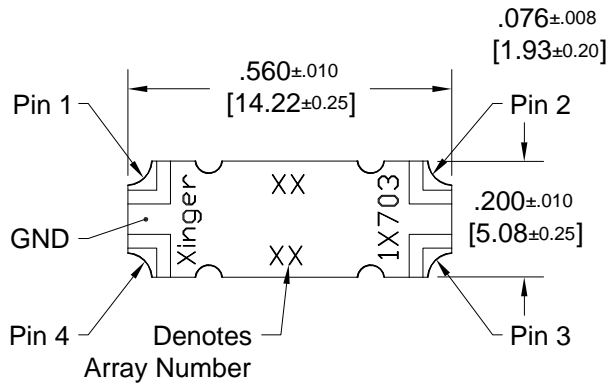

Side View

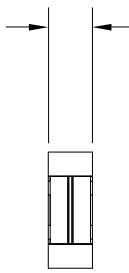

Bottom View (Far-side)

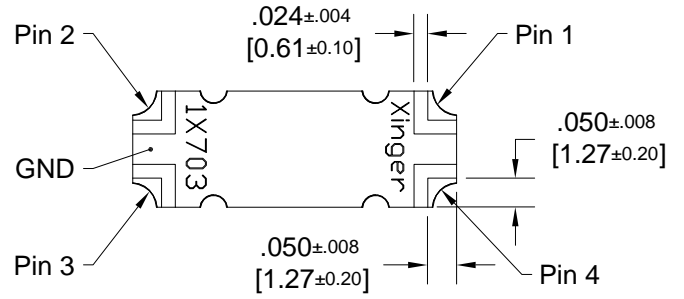

Dimensions are in Inches [Millimeters]
1X703 Rev A Mechanical Outline

Part Is Symmetric About All Axis