

Top View (Near-side)

Side View

Bottom View (Far-side)

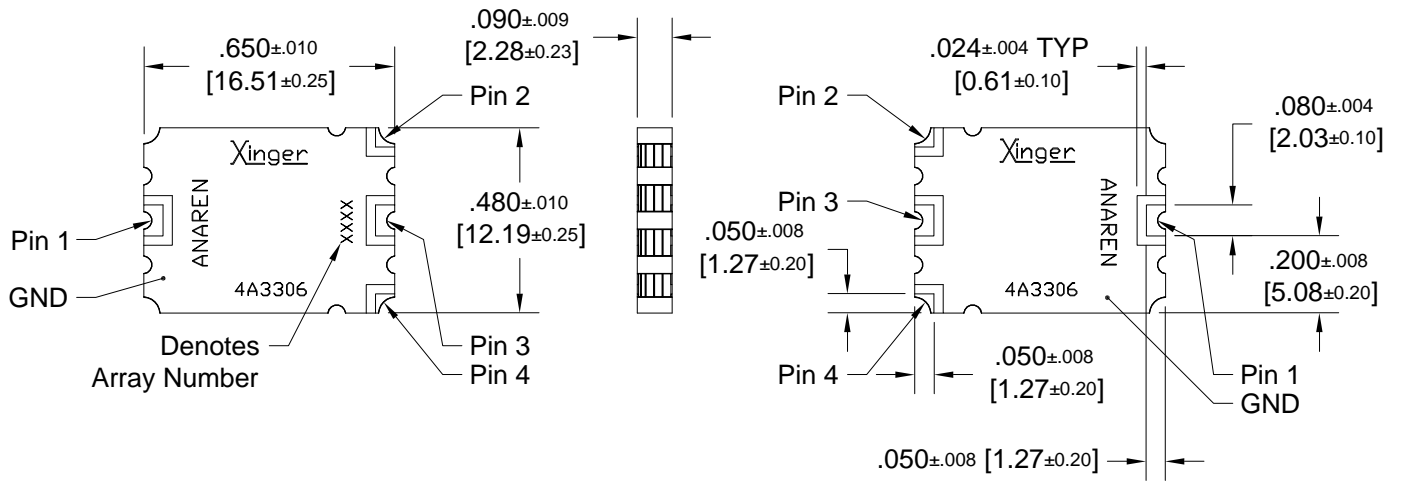

Dimensions are in Inches [Millimeters]
4A3306 Rev A Mechanical Outline