

To ensure proper electrical and thermal performance
there must be a ground plane with 100%
solder connection underneath the part

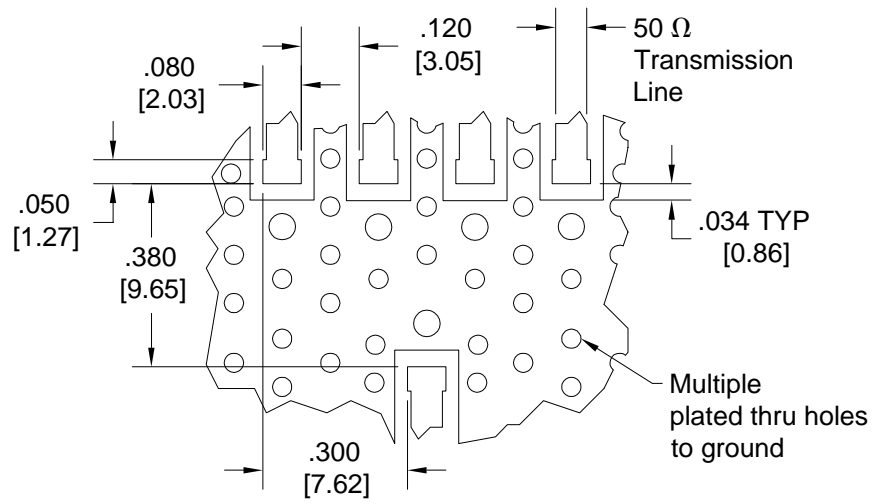
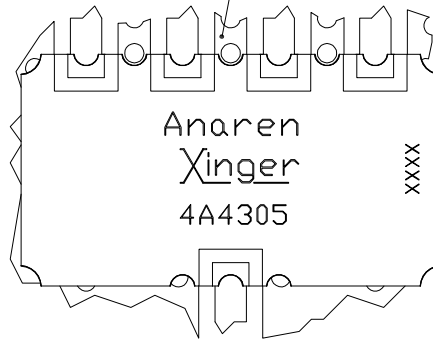

Dimensions are in Inches [Millimeters]
4A4305 Rev A Mounting Footprint