

Xinger®

Ultra Low Profile 1008 Balun 75Ω to 300Ω Balanced

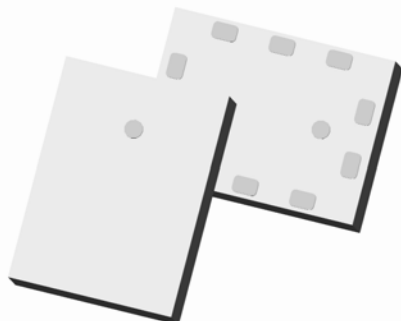

Description

The B0011E75300A00 is a low profile sub-miniature balanced to unbalanced transformer designed for differential inputs and output locations on next generation analog and digital TV chipsets in an easy to use surface mount package. The B0011E75300A00 is ideal for high volume manufacturing and is higher performance than traditional wire wound baluns. The B0011E75300A00 has an unbalanced port impedance of 75Ω and a 300Ω balanced port impedance. This transformation enables single ended signals to be applied to differential ports on modern semiconductors. The output ports have equal amplitude (-3dB) with 180 degree phase differential. The B0011E75300A00 is available on tape and reel for pick and place high volume manufacturing.

Detailed Electrical Specifications: Specifications subject to change without notice.

Features:	Parameter	ROOM (25°C)			Unit
		Min.	Typ.	Max	
• 48 – 1080 MHz	Frequency	48		1080	MHz
• 1.0 mm Height Profile	Unbalanced Port Impedance		75		Ω
• 75 Ohm to 2 x 150 Ohm	Balanced Port Impedance		300		Ω
• DVB-T, DVB-H and DVB-C	Return Loss	9	11		dB
• Low Insertion Loss	Insertion Loss*		1.3	1.6	dB
• Surface Mountable	Amplitude Balance		0.6	1.5	dB
• Tape & Reel	Phase Balance		6	15	Degrees
• Non-conductive Surface	CMRR		28		dB
• RoHS Compliant	Power Handling			TBD	Watts
	Operating Temperature	-55		+85	°C

* Insertion Loss stated at room temperature (Insertion Loss is approximately 0.15 dB higher at +85 °C). All performances stated for recommended operation with external circuitry.

Outline Drawing

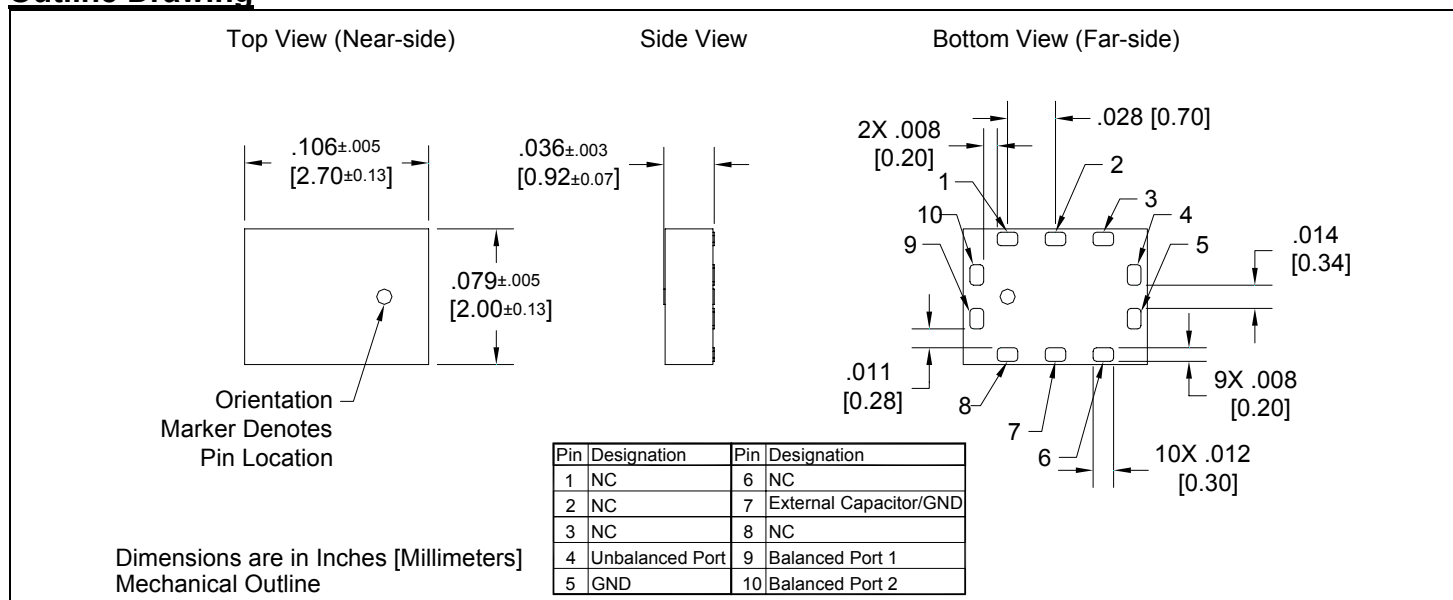

Typical Performance with Two External 82pF Capacitors (test/specification condition)

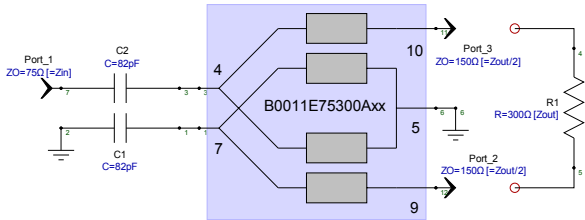
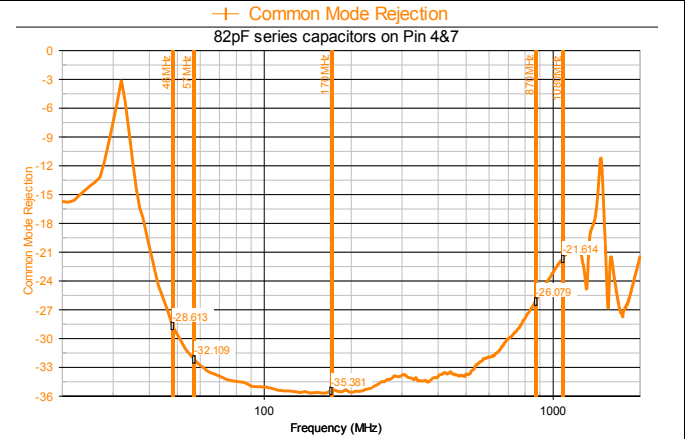
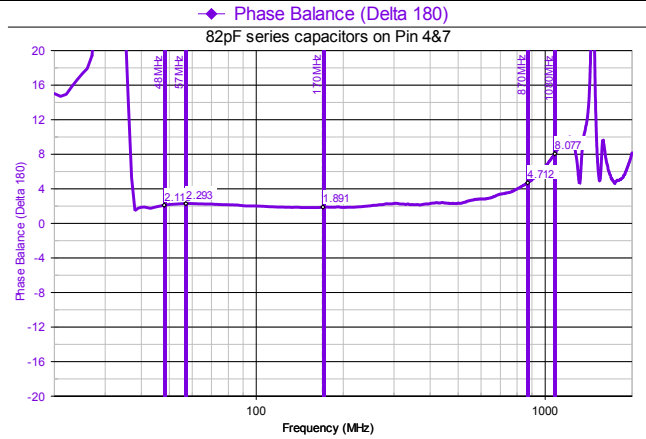
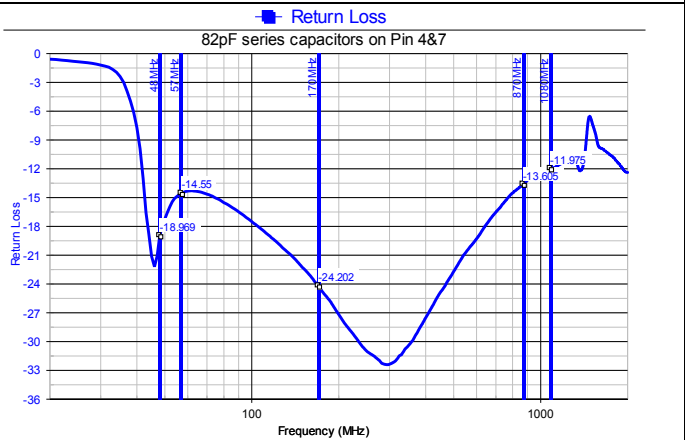
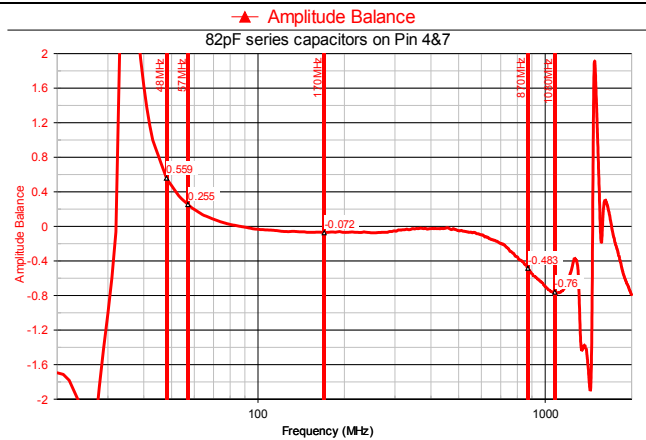
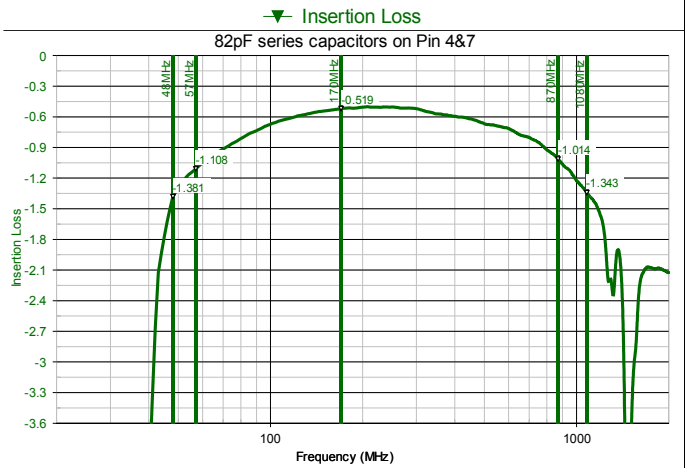

Figure 1 The Balun with external capacitors on both low impedance ports (nominal/test configuration). The two capacitors improve the insertion loss and return loss in the 40-200MHz range over that of the basic balun.



Typical Performance with One External 82pF Capacitor

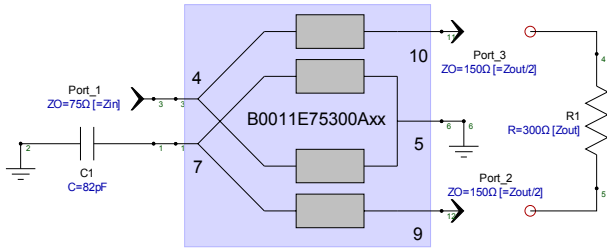
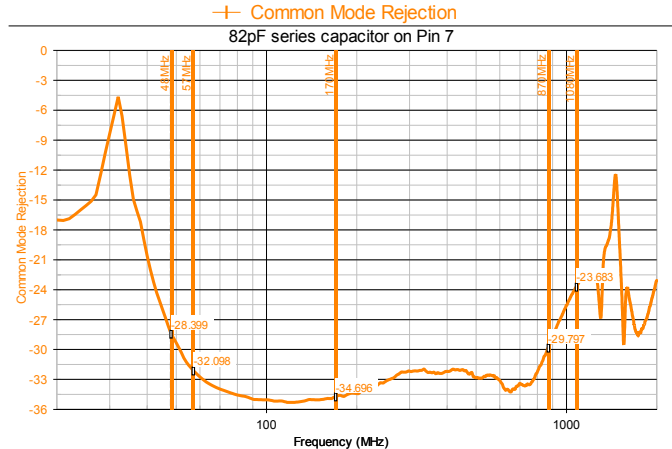
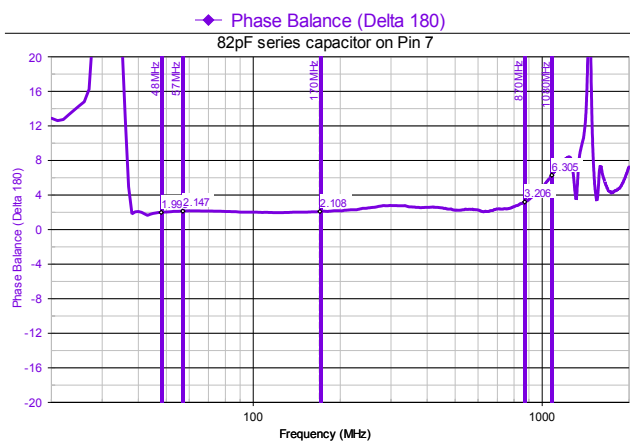
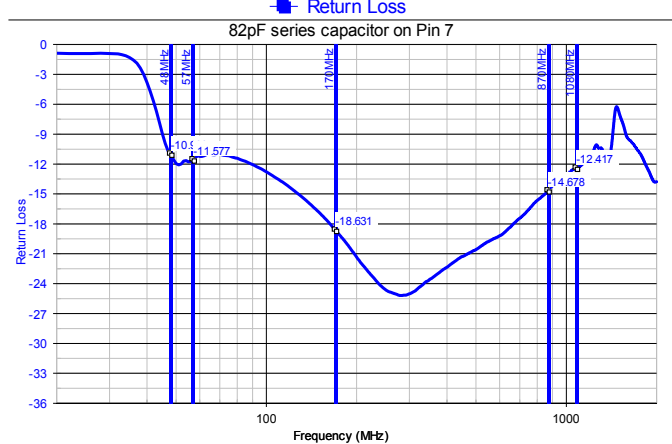
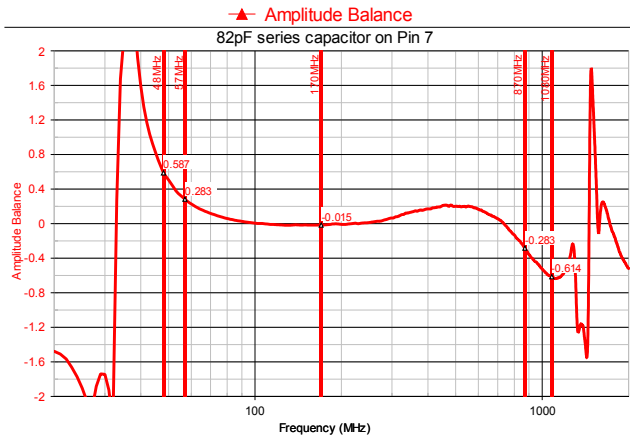
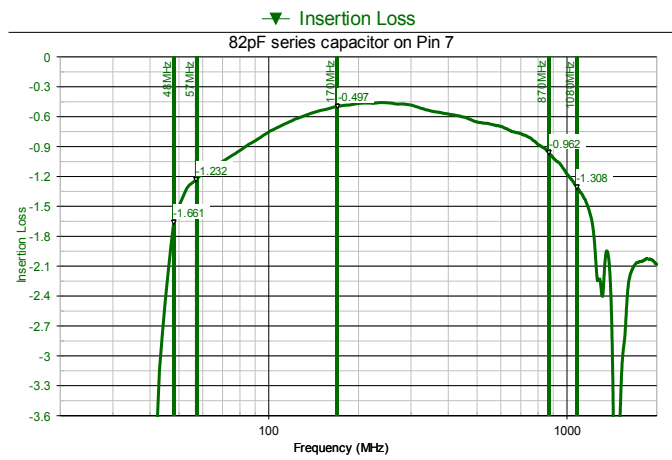

Figure 2 The Balun with an external capacitor on the low impedance ground pin. This improves insertion loss and return loss in the 40-200MHz range over that of the basic configuration. The capacitor value can be changed some to get a slightly different performance. A series capacitor with just pin 4 does NOT produce identical results as the one just in series with pin 7.



Typical Performance with no External Components

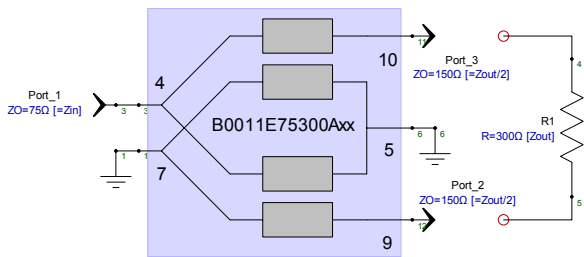
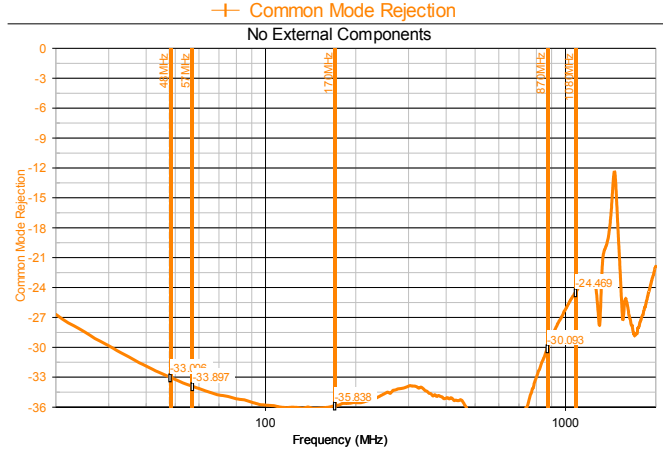
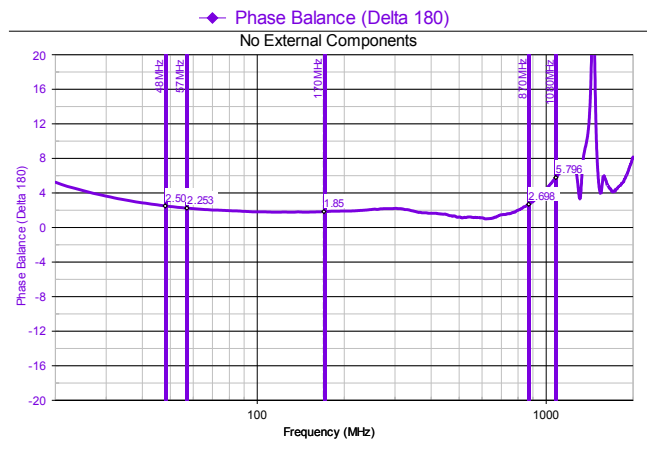
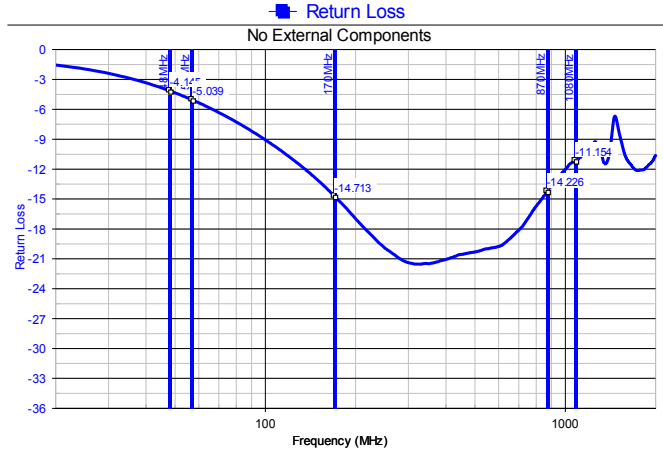
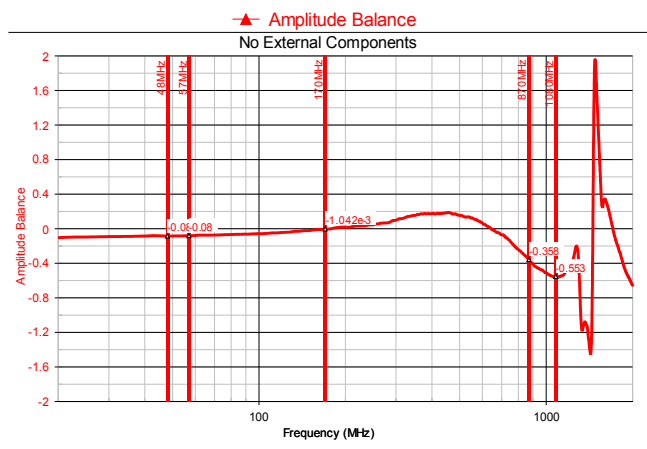
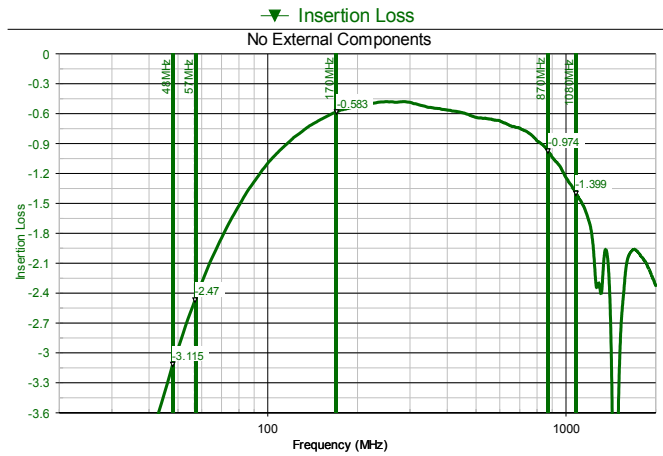

Figure 3 The Balun in it's basic configuration with no external components.



Additional Configurations

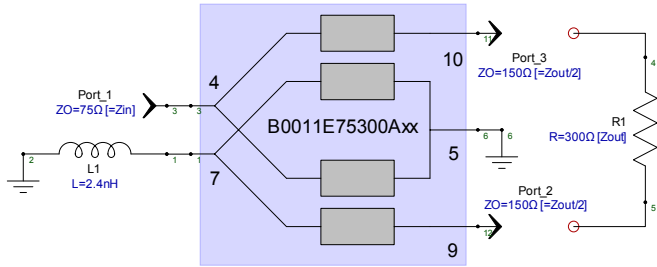

Figure 4 The balun with an external inductor in the low impedance ground path. This improves the insertion loss, return loss and balanced performance in the 870-1080MHz range. This inductance can be realized as a transmission line (dimensions will depend on the PCB material and ground plane distance). The added inductance can be used in conjunction with the external capacitors. When mounted with high groundplane spacing, part of this inductance comes automatically from the increased inductance of the typical via to ground.

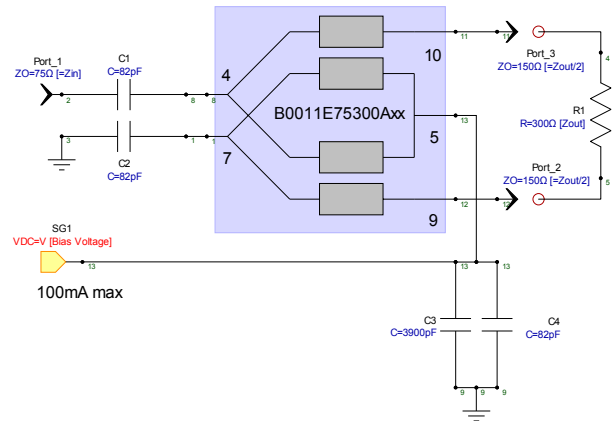

Figure 5 Biasing the balanced signals thru the balun. Depend on the quality of “C3” the additional capacitor “C4” may not be needed. The DC-resistance from the bias point thru to each of the outputs are $10 \pm 4\Omega$. It is important to keep inductance to a minimum from pin 5 to ground or balanced performance will suffer. When used with high groundplane spacings it is recommended to have two or more via to ground.

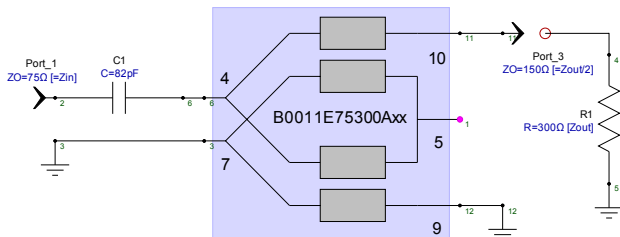

Figure 6 Using the balun as a single ended to single ended impedance transformer (Unun). Pin 5 must be open circuit. It is recommended to use the 82pF on the low impedance side to improve the insertion loss and return loss in the 50-200MHz range. Note that pins 4 & 7 can only be interchanged if pins 9 7 10 are also interchanged, otherwise performance will suffer.



Distortion Considerations:

This balun does NOT contain any ferrite materials and are as such distortion free. Very, very low levels of distortion can arise from dissimilar metals on the contact pads of the part (Cu-Ni-Au) and from inter-metallic contaminations within the part.

Power Handling Considerations:

The RF-power handling capability of these baluns depends on the temperature at the mounted interface (base plate temperature), and whether or not DC-bias is feed through the part. The power handling specified is for a mounted temperature of 85°C and no DC-bias and is based on a maximum operating temperature of the part itself of 125°C (do not exceed this).

The maximum power handling relates to the dissipated power within the part and is therefore a function of insertion loss. The insertion loss of this device changes within the specified band. Thus if operated with a narrowband signal at either band edge (this is what is specified) it will have less power handling than if operated closer to the center of the band or if operated with a very wideband signal. If signals arrive at the balun that are out of the specified band, these must be included in the total dissipated power calculation. However the deteriorating return loss will eliminate some of this power.

The dissipated RF power can be estimated as;

$$P_{RF,diss} = P_{in} \left(1 - 10^{-\left(\frac{RL_{dB}}{10}\right)} \right) \left(1 - 10^{-\left(\frac{IL_{dB}}{10}\right)} \right) [W]$$

Where:

- P_{in} is the input power, either on the low impedance side, single ended or the combined differential power on the balanced side, depending on the feeding direction.
- RL_{dB} is the return loss in dB associated with the feeding port. I.e. if feed from the balanced side then the balanced return loss must be used (this however is very similar to the single ended return loss).
- IL_{dB} is the insertion loss **at the operating temperature of the device**.

Below the dissipated power is shown at a normalized 1W input power for the balun internal temperature of 125°C.



Dissipated power, normalized to 1W input power, at 125°C Part temperature

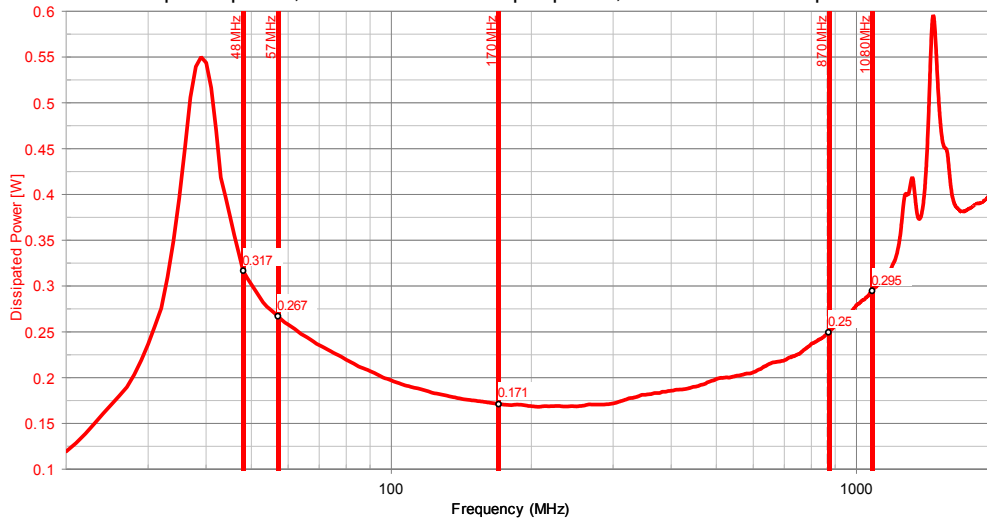

When used with DC-biasing the RF-power must be de-rated with the amount of DC power dissipated;

$$P_{dc,diss} = (R_{out1} \parallel R_{out2}) I_{dc}^2 \approx 7 I_{dc}^2 [W]$$

The total dissipated power cannot exceed **TBD**.

When the duty cycle is not 100% the input power can be averaged, however the instantaneous input power should never exceed **TBD**.



Mounting Configuration:

In order for Xinger surface mount components to work optimally, the proper impedance transmission lines must be used to connect to the RF ports. If this condition is not satisfied, insertion loss, Isolation and VSWR may not meet published specifications.

All of the Xinger components are constructed from softboard composites which possess excellent electrical and mechanical stability having X and Y thermal coefficient of expansion (CTE) of 19 ppm/°C.

An example of the PCB footprint used in the testing of these parts is shown below. In specific designs, the transmission line widths need to be adjusted to the unique dielectric coefficients and thicknesses as well as varying pick and place equipment tolerances.

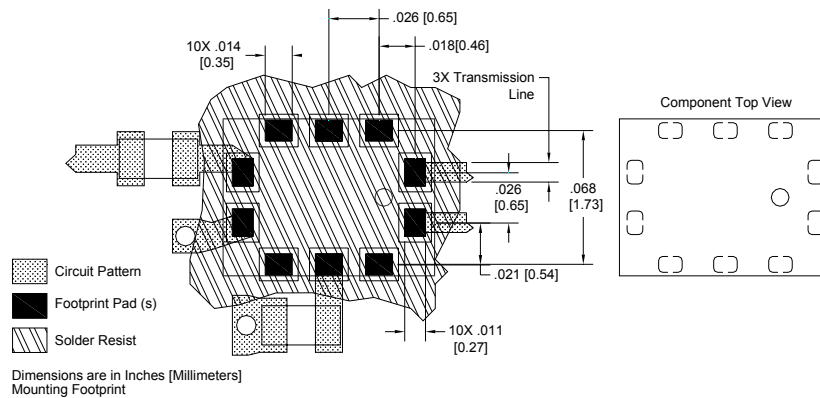

The material used for testing is 8mil Rogers 4003. For a ground plane spacing much larger than this the single via at pin 5 should be replaced with at least 2 via and if possible a coplanar ground.



Packaging and Ordering Information

Parts are available in reel and are packaged per EIA 481-2. Parts are oriented in tape and reel as shown below. Minimum order quantities are 4000 per reel. See Model Numbers below for further ordering information.

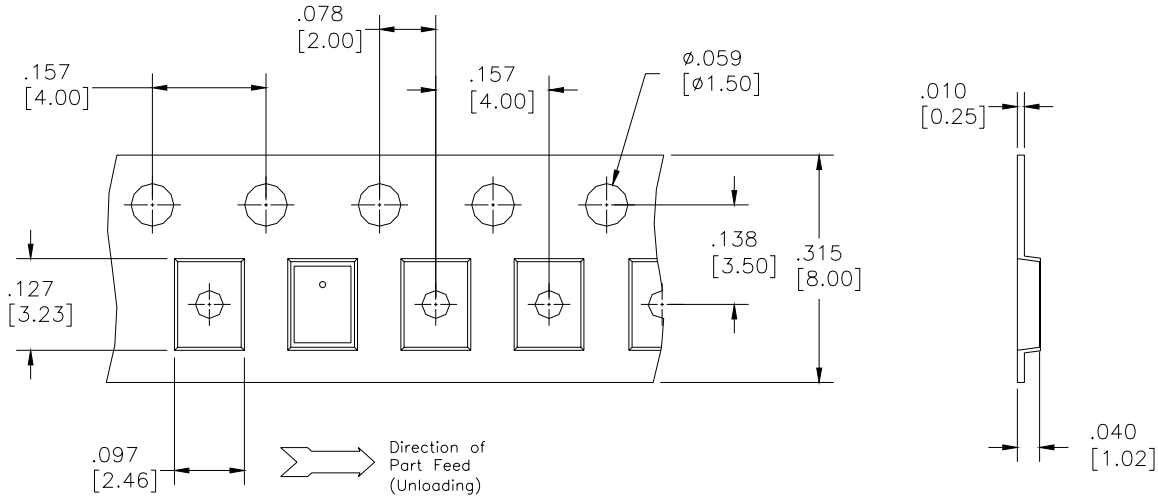

Dimensions are in inches [mm]

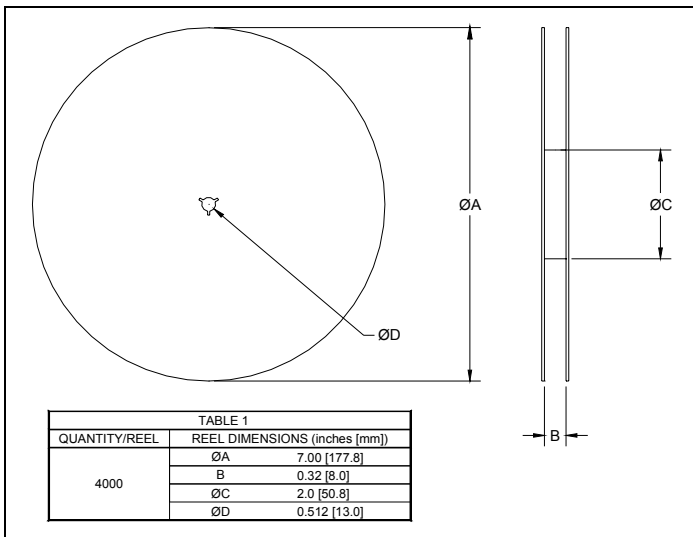

BD 2425 J 50 100 A 00

Function	Frequency	Package Dimensions	Unbalanced Impedance	Balanced Impedance + Coupling	Plating Finish	Codes
B = Balun BD = Balun + DC F = Filter FB = Filter / Balun C = 3dB Coupler DC = Directional J = RF Jumper X = RF cross over	0110 = 100 – 1000 MHz 0810 = 800 – 1000 MHz 0922 = 950 – 2150 MHz 0826 = 800 – 6200 MHz 1222 = 1200 – 2200 MHz 1416 = 1400 – 1600 MHz 1722 = 1700 – 2200 MHz 2326 = 2300 – 2600 MHz 2425 = 2400 – 2500 MHz 3150 = 3100 – 5000 MHz 3436 = 3400 – 3600 MHz 4859 = 4800 – 5900MHz 5153 = 5100 – 5300 MHz 5159 = 5100 – 5900 MHz 5759 = 5700 – 5900 MHz	A = 150 x 150 mils (4mm x 4mm) C = 120 x 120 mils (3mm x 3mm) E = 100 x 80 mils (2.5mm x 2mm) J = 80 x 50 mils (2mm x 1.25mm) L = 60 x 30 mils (1.5mm x 0.75mm) N = 40 x 40 mils (1mm x 1mm)	50 = 50 Ohm 75 = 75 Ohm	25 = 25 Ω Balanced 30 = 30 Ω Balanced 50 = 50 Ω Balanced 75 = 75 Ω Balanced 100 = 100 Ω Balanced 150 = 150 Ω Balanced 200 = 200 Ω Balanced 300 = 300 Ω Balanced 400 = 400 Ω Balanced 03 = 3dB Hybrid 10 = 10dB Directional 20 = 20dB Directional	A = Gold P = Tin-Lead	

USA/Canada: (315) 432-8909
Toll Free: (800) 411-6596
Europe: +44 2392-232392

Available on Tape and Reel for Pick and Place Manufacturing.



Anaren

What'll we think of next?™