

Xinger®

Ultra Low Profile 0805 Balun 75Ω to 75Ω Balanced

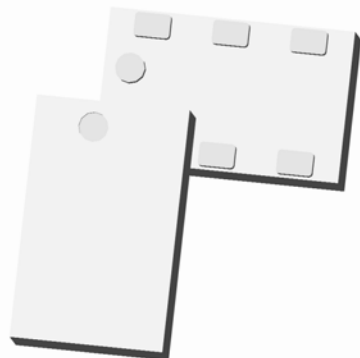

Description

The B0922J7575A50 is a low cost, low profile sub-miniature unbalanced to balanced transformer designed for differential inputs and output locations on modern chipsets in an easy to use surface mount package covering dual polarized commercial Satellite bands 950 MHz – 1450 MHz & 1650 MHz – 2150 MHz. The B0922J7575A50 is ideal for high volume manufacturing and delivers higher performance than traditional wire wound baluns. The B0922J7575A50 has an unbalanced port impedance of 75Ω and a 75Ω balanced port impedance*. This transformation enables single ended signals to be applied to differential ports on modern integrated chipsets. The output ports have equal amplitude (-3dB) with 180 degree phase differential. The B0922J7575A50 is available on tape and reel for pick and place high volume manufacturing.

Detailed Electrical Specifications: Specifications subject to change without notice.

Features:	Parameter	ROOM (25°C)			Unit
		Min.	Typ.	Max	
<ul style="list-style-type: none"> • 950 – 2150 MHz • 0.7mm Height Profile • 75 Ohm to 2 x 37.5 Ohm • Low Insertion Loss • Sat LNB Chipset Compliant • Input to Output DC Isolation • Surface Mountable • Tape & Reel • Non-conductive Surface • RoHS Compliant 	Frequency	950		2150	MHz
	Unbalanced Port Impedance		75		Ω
	Balanced Port Impedance		75		Ω
	Return Loss	12	15		dB
	Insertion Loss*		0.8	1.1	dB
	Amplitude Balance		1.0	1.4	dB
	Phase Balance		3	9	Degrees
	CMRR		25		dB
	Power Handling			0.5	Watts
	Operating Temperature	-55		+85	°C

* Insertion Loss stated at room temperature (Insertion Loss is approximately 0.1 dB higher at +85 °C)

Outline Drawing

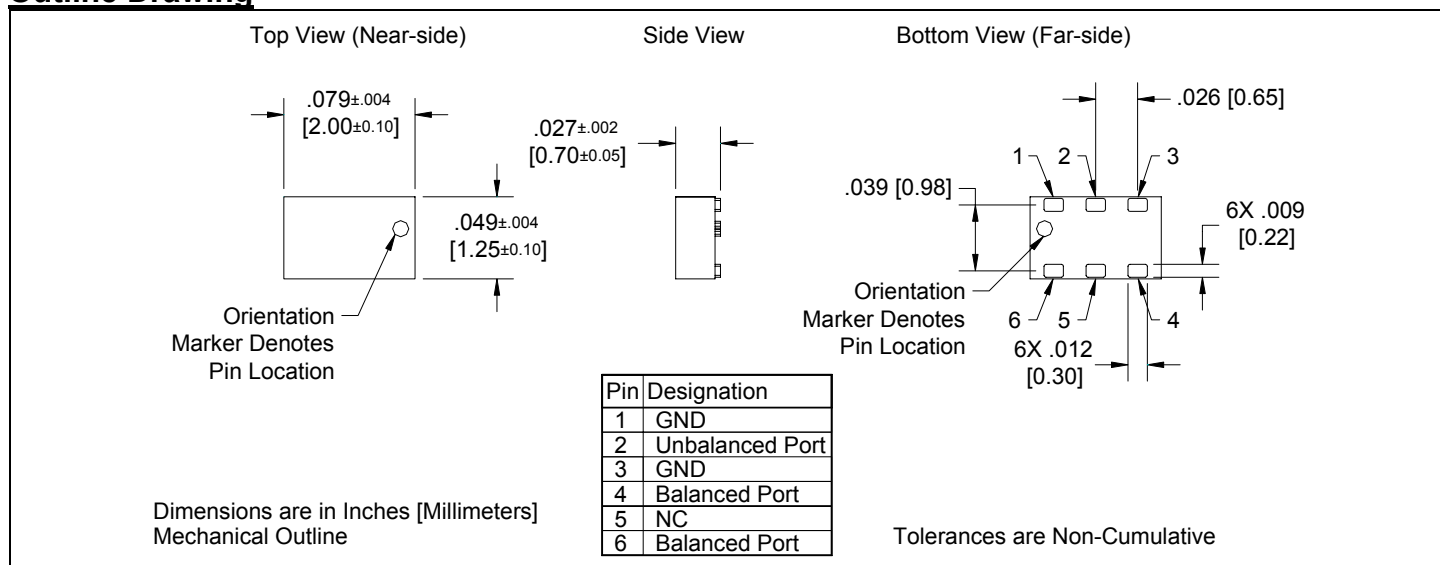

Model B0922J7575A50

Rev B

Anaren®

Typical Performance: 600 MHz. to 2600 MHz.

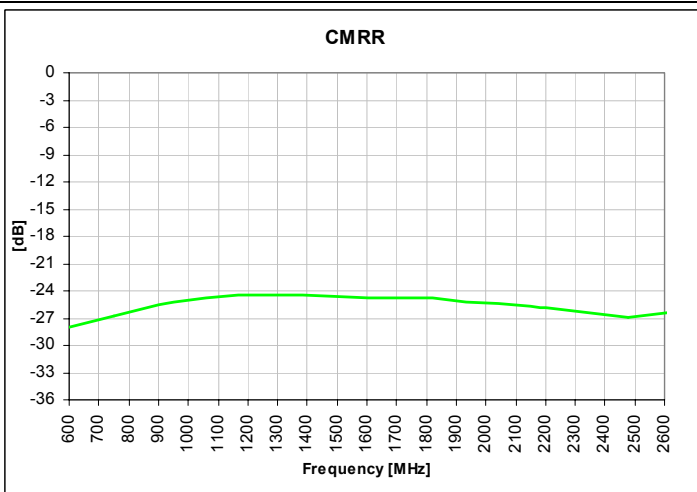
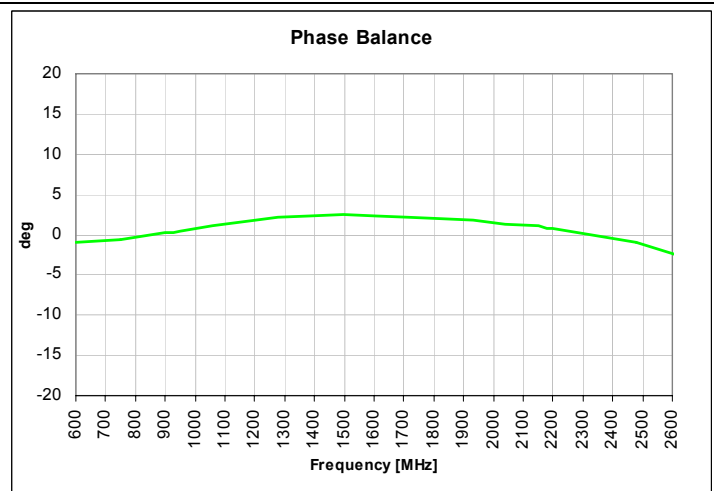
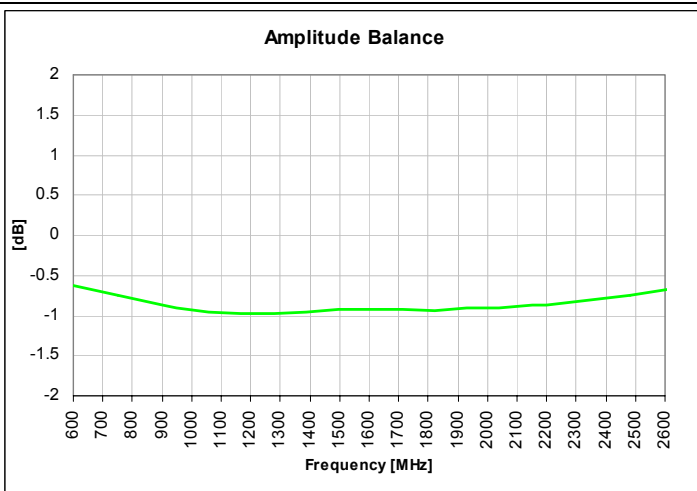
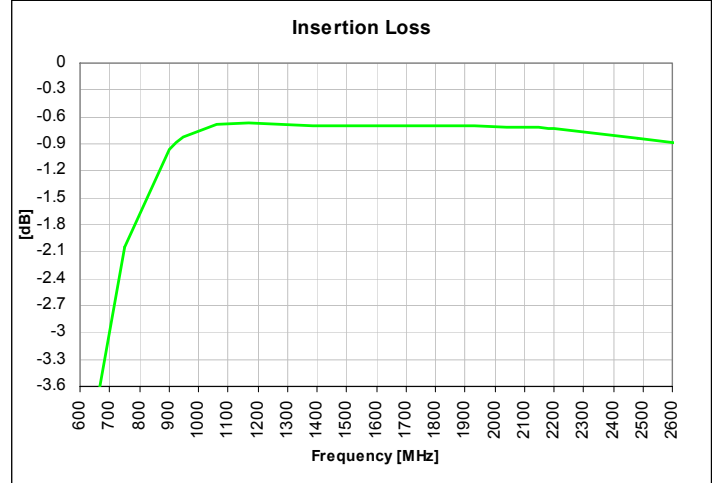
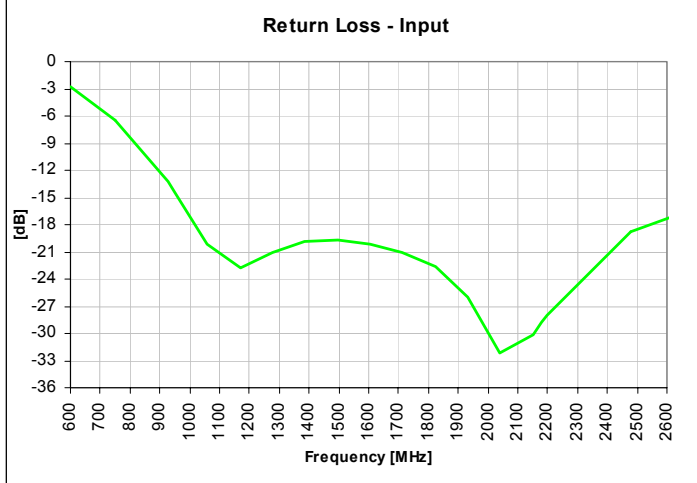

USA/Canada: (315) 432-8909
Toll Free: (800) 411-6596
Europe: +44 2392-232392

Available on Tape and Reel for Pick and Place Manufacturing.



Anaren

What'll we think of next?™

Wide Band Performance: 500 MHz. to 8000 MHz.

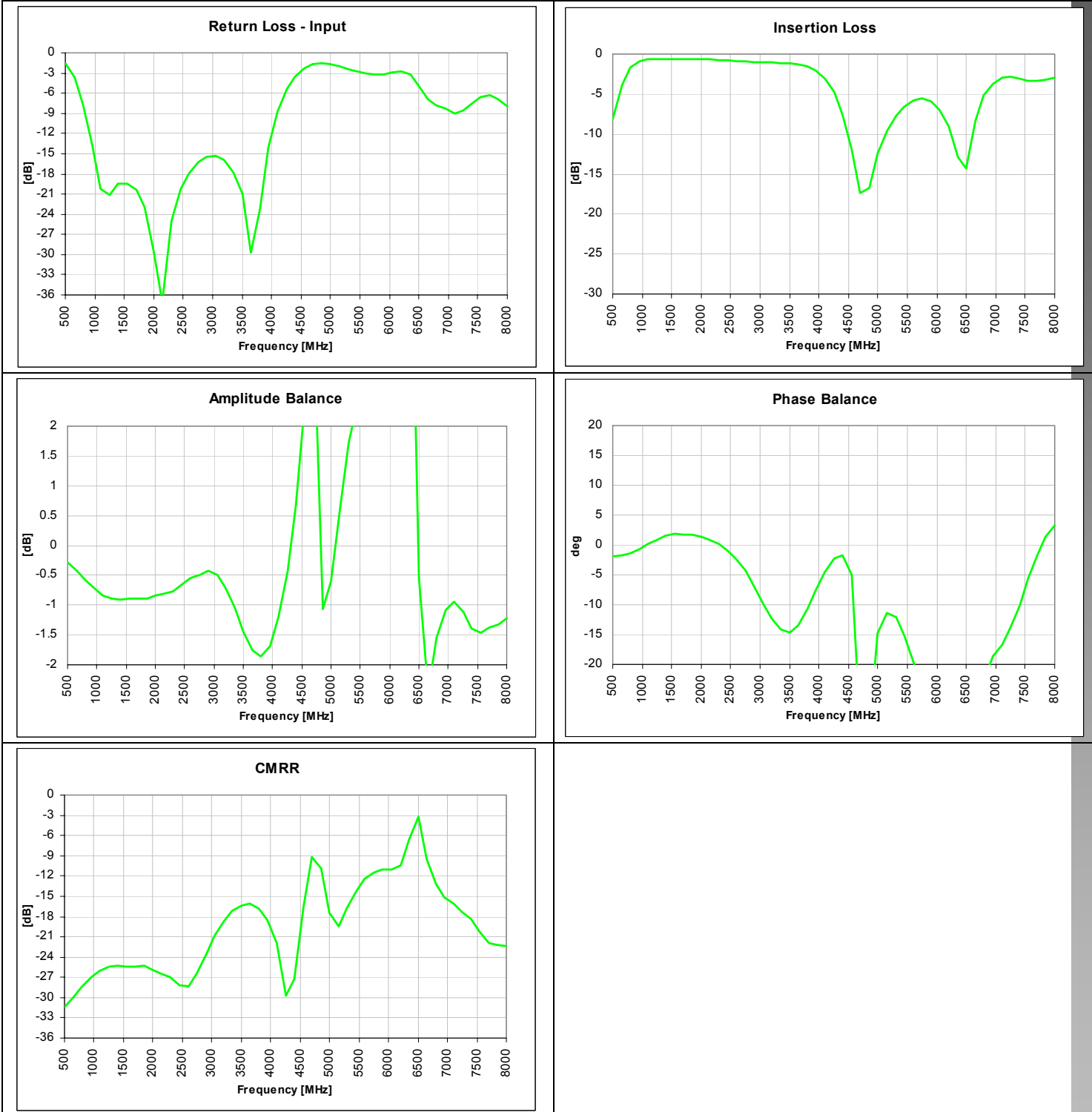

Mounting Configuration:

In order for Xinger surface mount components to work optimally, the proper impedance transmission lines must be used to connect to the RF ports. If this condition is not satisfied, insertion loss, Isolation and VSWR may not meet published specifications.

All of the Xinger components are constructed from ceramic filled PTFE composites which possess excellent electrical and mechanical stability having X and Y thermal coefficient of expansion (CTE) of 17 ppm/°C.

An example of the PCB footprint used in the testing of these parts is shown below. In specific designs, the transmission line widths need to be adjusted to the unique dielectric coefficients and thicknesses as well as varying pick and place equipment tolerances.

Mounting Footprint

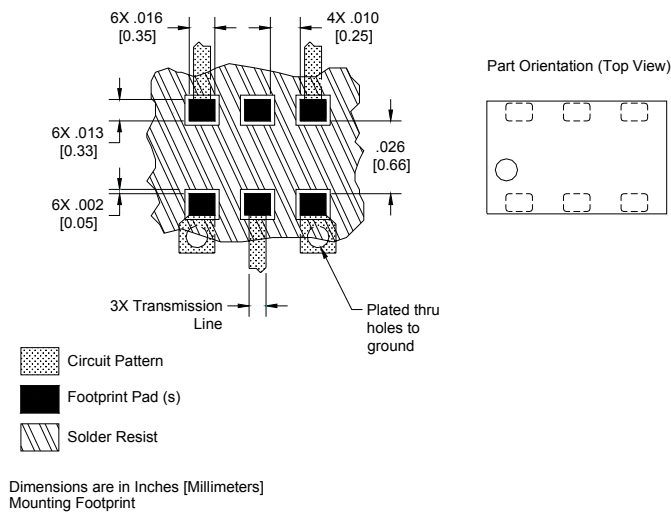

Packaging and Ordering Information

Parts are available in reel and are packaged per EIA 481-2. Parts are oriented in tape and reel as shown below. Minimum order quantities are 4000 per reel. See Model Numbers below for further ordering information.

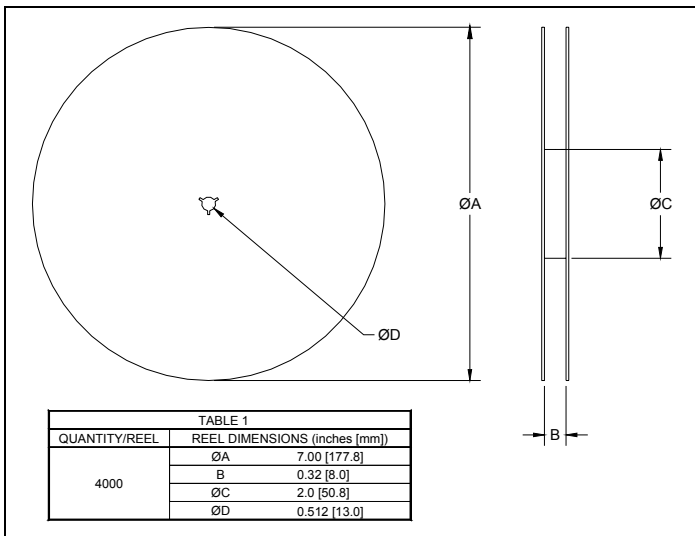
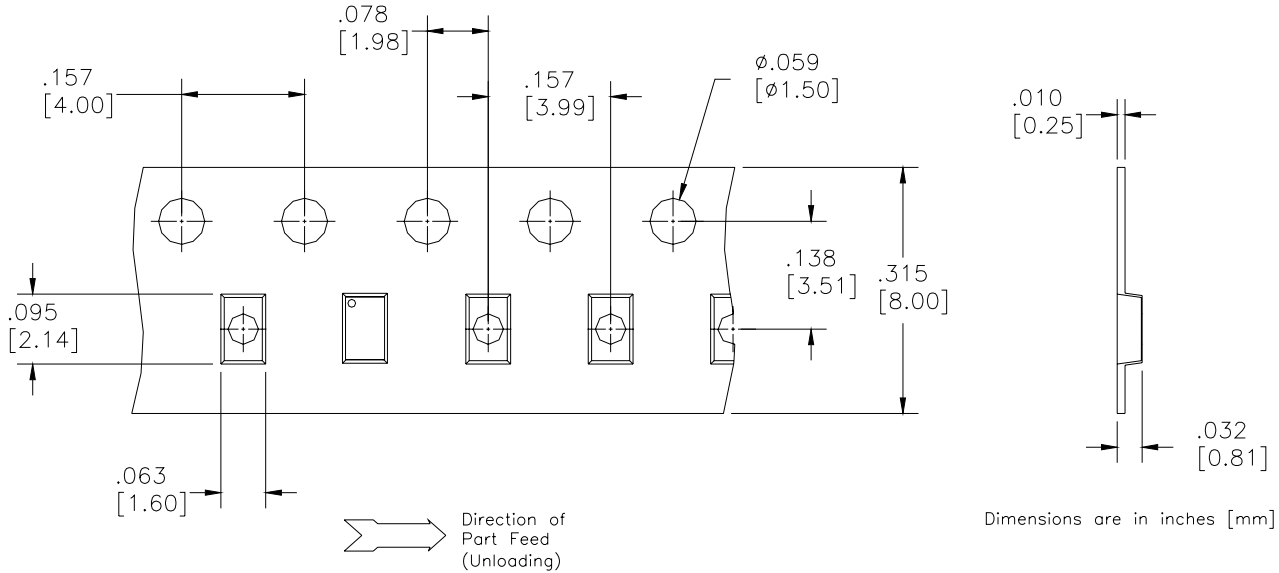

BD 2425 J 50 100 A 00

Function	Frequency	Package Dimensions	Unbalanced Impedance	Balanced Impedance + Coupling	Plating Finish	Codes
B = Balun	0110 = 100 – 1000 MHz	A = 150 x 150 mils (4mm x 4mm)	50 = 50 Ohm	25 = 25 Ω Balanced	A = Gold	
BD = Balun + DC	0810 = 800 – 1000 MHz	C = 120 x 120 mils (3mm x 3mm)	75 = 75 Ohm	30 = 30 Ω Balanced	P = Tin-Lead	
F = Filter	0922 = 950 – 2150 MHz	E = 100 x 80 mils (2.5mm x 2mm)		50 = 50 Ω Balanced		
FB = Filter / Balun	0826 = 800 – 2600 MHz	J = 80 x 50 mils (2mm x 1.25mm)		75 = 75 Ω Balanced		
C = 3dB Coupler	1222 = 1200 – 2200 MHz	L = 60 x 30 mils (1.5mm x 0.75mm)		100 = 100 Ω Balanced		
DC = Directional	1416 = 1400 – 1600 MHz	N = 40 x 40 mils (1mm x 1mm)		150 = 150 Ω Balanced		
J = RF Jumper	1722 = 1700 – 2200 MHz			200 = 200 Ω Balanced		
X = RF cross over	2326 = 2300 – 2600 MHz			300 = 300 Ω Balanced		
	2425 = 2400 – 2500 MHz			400 = 400 Ω Balanced		
	3150 = 3100 – 5000 MHz			03 = 3dB Hybrid		
	3436 = 3400 – 3600 MHz			10 = 10dB Directional		
	4859 = 4800 – 5900MHz			20 = 20dB Directional		
	5153 = 5100 – 5300 MHz					
	5159 = 5100 – 5900 MHz					
	5759 = 5700 – 5900 MHz					

USA/Canada: (315) 432-8909
 Toll Free: (800) 411-6596
 Europe: +44 2392-232392

Available on Tape and Reel for Pick and Place Manufacturing.



Anaren

What'll we think of next?™