

# Xinger®

## Ultra Small Low Profile 0603 Balun 50Ω to 200Ω Balanced

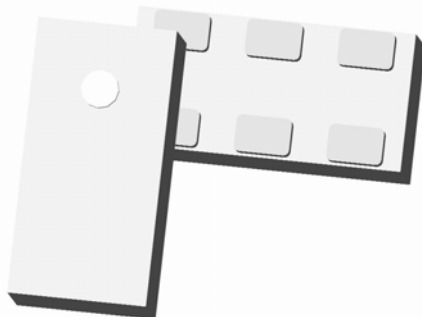

### Description

The BD2326L50200A00 is an ultra-small low profile balanced to unbalanced transformer designed for differential inputs and output locations on next generation wireless chipsets in an easy to use surface mount package covering 802.11b+g+n. The BD2326L50200A00 is ideal for high volume manufacturing and is higher performance than traditional ceramic baluns. The BD2326L50200A00 has an unbalanced port impedance of 50Ω and a 200Ω balanced port impedance. This transformation enables single ended signals to be applied to differential ports on modern integrated chipsets. The output ports have equal amplitude (-3dB) with 180 degree phase differential. The BD2326L50200A00 is available on tape and reel for pick and place high volume manufacturing.

### Detailed Electrical Specifications: Specifications subject to change without notice.

Features:	Parameter	ROOM (25°C)			Unit
		Min.	Typ.	Max	
<ul style="list-style-type: none"> <li>• 2300 – 2600 MHz</li> <li>• 0.7mm Height Profile</li> <li>• 50 Ohm to 2 x 100 Ohm</li> <li>• 802.11 b+g +n Compliant</li> <li>• Low Insertion Loss</li> <li>• Input to Output DC Isolation</li> <li>• Surface Mountable</li> <li>• Tape &amp; Reel</li> <li>• Non-conductive Surface</li> <li>• RoHS Compliant</li> </ul>	Frequency	2300		2600	MHz
	Unbalanced Port Impedance		50		Ω
	Balanced Port Impedance		200		Ω
	Return Loss	12	18		dB
	Insertion Loss*		0.9	1.1	dB
	Amplitude Balance		0.4	0.8	dB
	Phase Balance		3	9	Degrees
	CMRR		29		dB
	Power Handling			0.5	Watts
	Operating Temperature	-55		+85	°C

\* Insertion Loss stated at room temperature (Insertion Loss is approximately 0.1 dB higher at +85 °C)

### Outline Drawing

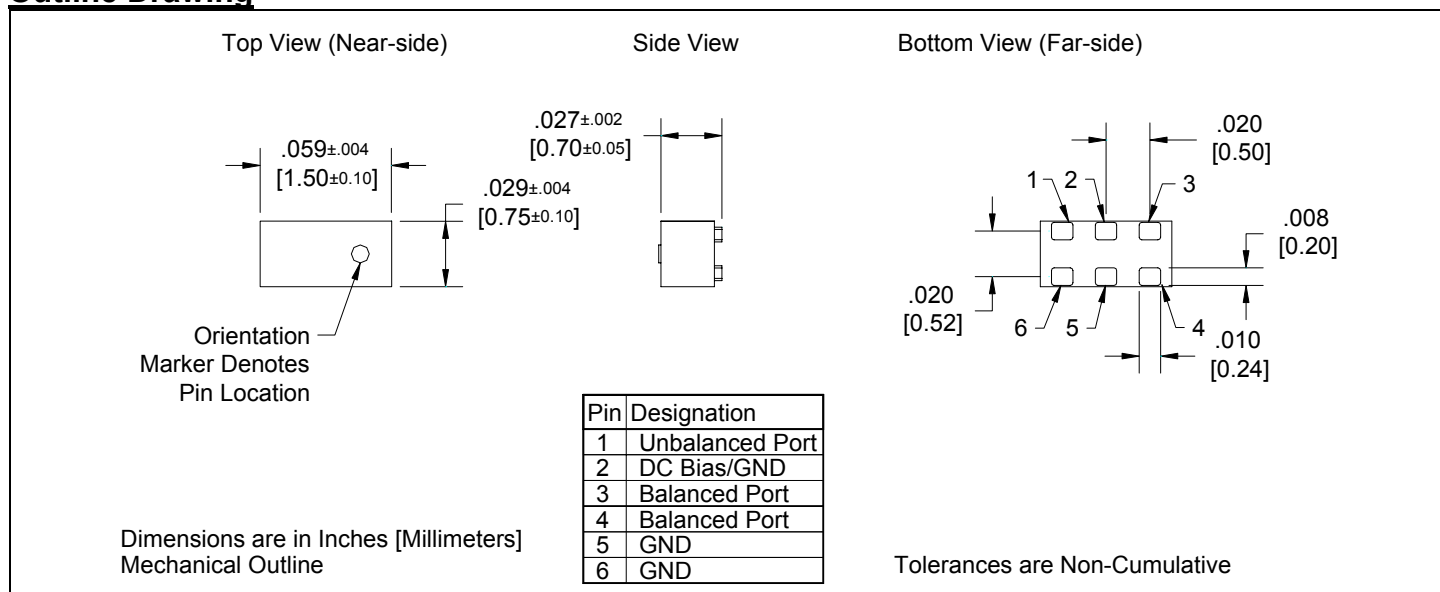

**Model BD2326L50200A00**

Rev B

**Anaren<sup>®</sup>**

USA/Canada: (315) 432-8909  
Toll Free: (800) 411-6596  
Europe: +44 2392-232392

Available on Tape and  
Reel for Pick and Place  
Manufacturing.



**Anaren**

What'll we think of next?™

### Typical Broadband Performance: 500 MHz. to 8000 MHz.

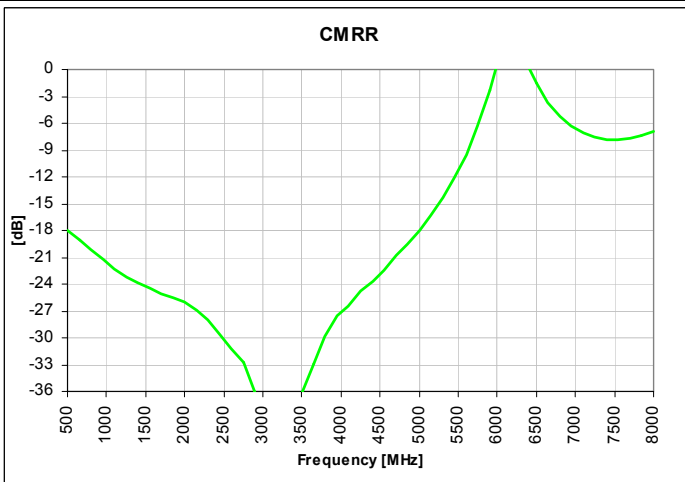
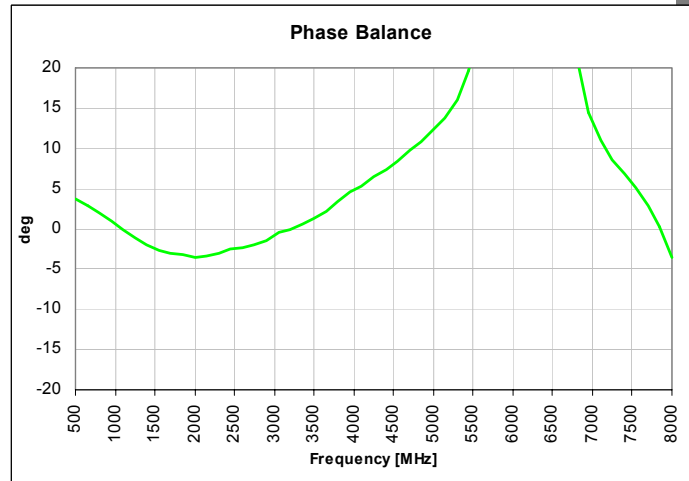
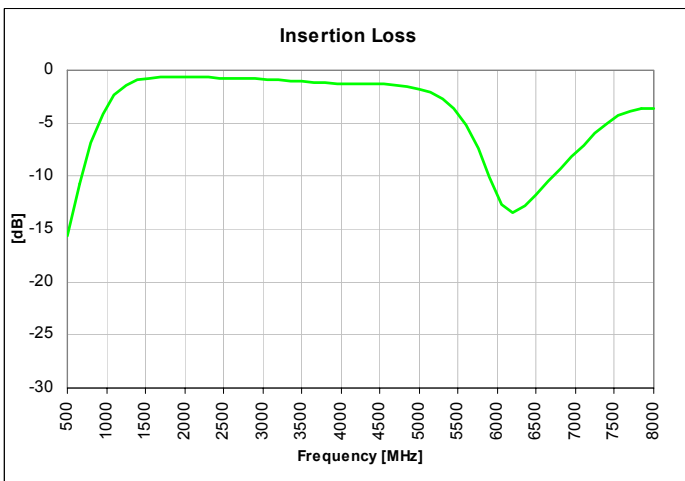
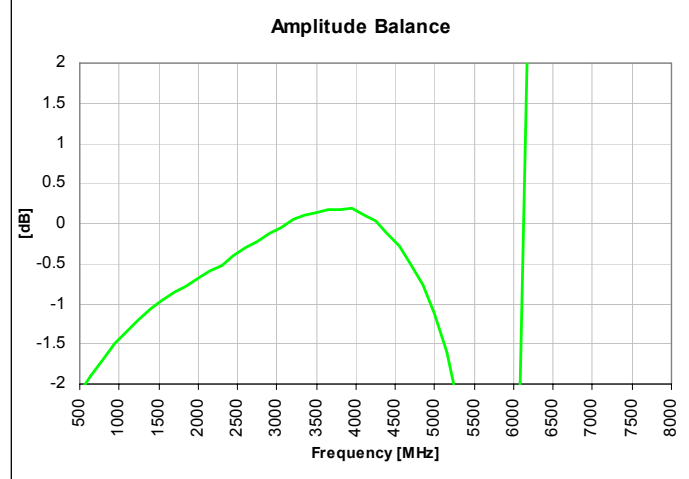
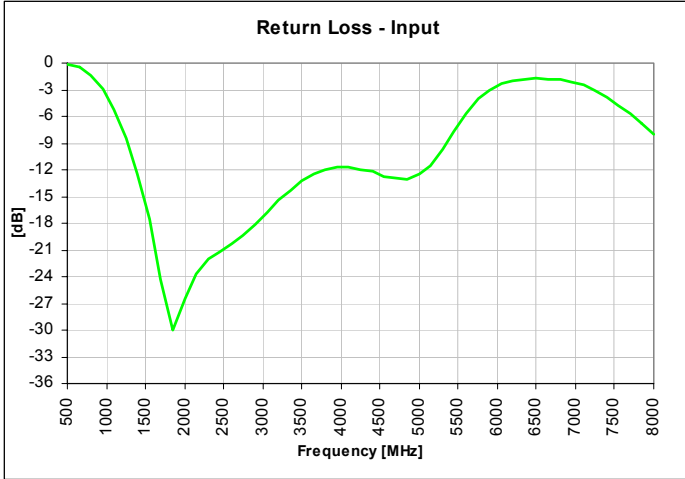

## Typical Performance: 2200 MHz. to 2700 MHz.

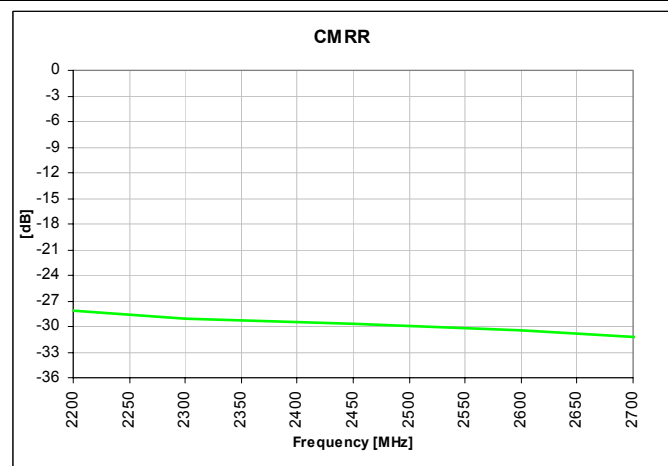
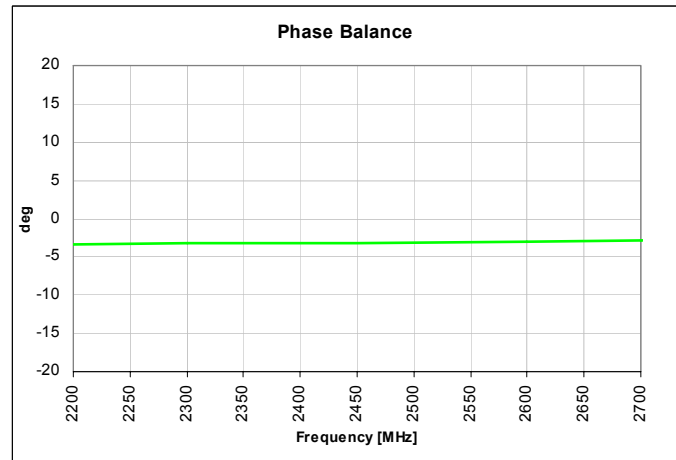
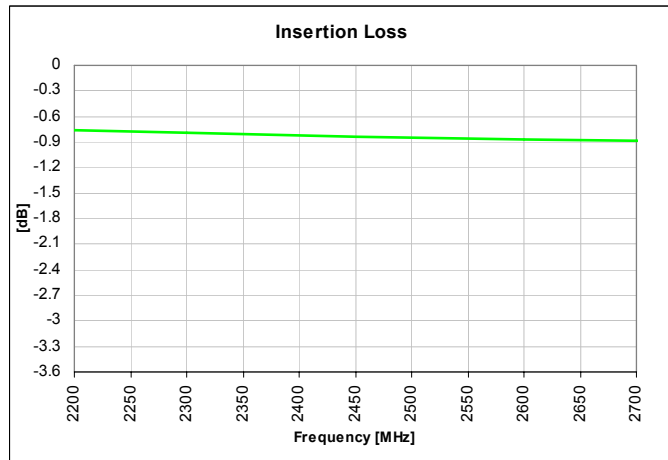
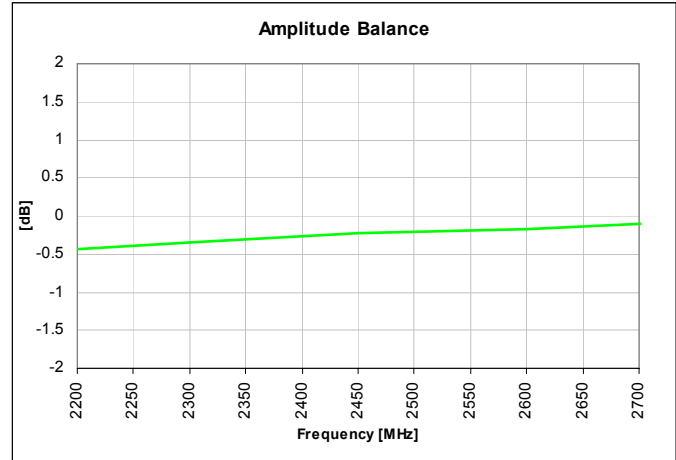
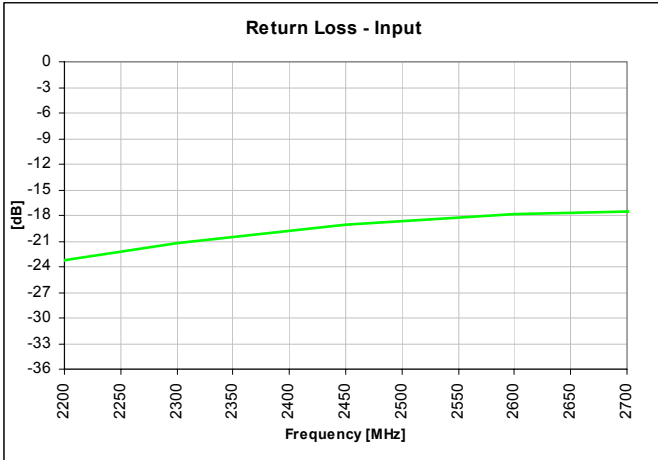

USA/Canada: (315) 432-8909  
 Toll Free: (800) 411-6596  
 Europe: +44 2392-232392

Available on Tape and Reel for Pick and Place Manufacturing.



# Anaren

What'll we think of next?™

### Mounting Configuration:

In order for Xinger surface mount components to work optimally, the proper impedance transmission lines must be used to connect to the RF ports. If this condition is not satisfied, insertion loss, Isolation and VSWR may not meet published specifications.

All of the Xinger components are constructed from ceramic filled PTFE composites which possess excellent electrical and mechanical stability having X and Y thermal coefficient of expansion (CTE) of 17 ppm/°C.

An example of the PCB footprint used in the testing of these parts is shown below. An example of a DC-biased footprint is also shown below. In specific designs, the transmission line widths need to be adjusted to the unique dielectric coefficients and thicknesses as well as varying pick and place equipment tolerances.

#### No Bias Footprint

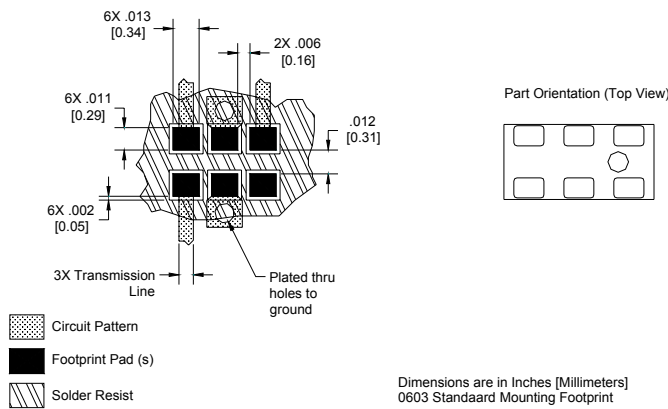

#### DC Bias Footprint

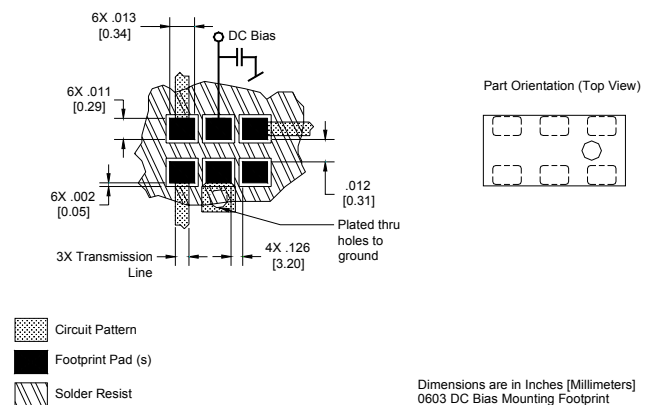

## Packaging and Ordering Information

Parts are available in reel and are packaged per EIA 481-2. Parts are oriented in tape and reel as shown below. Minimum order quantities are 4000 per reel. See Model Numbers below for further ordering information.

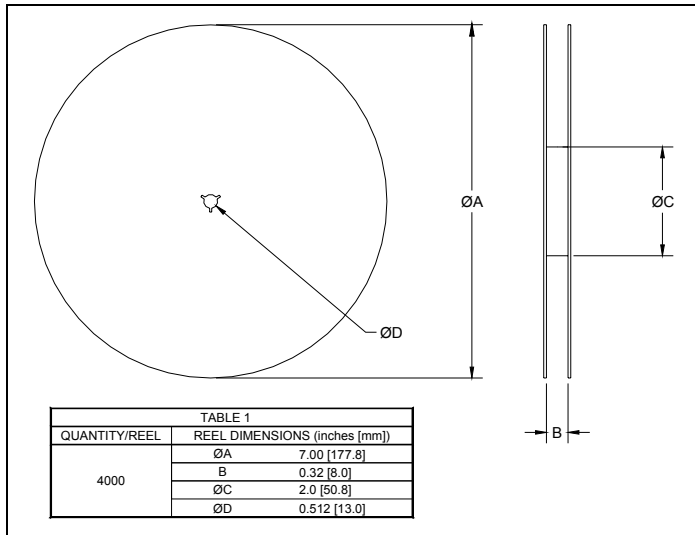
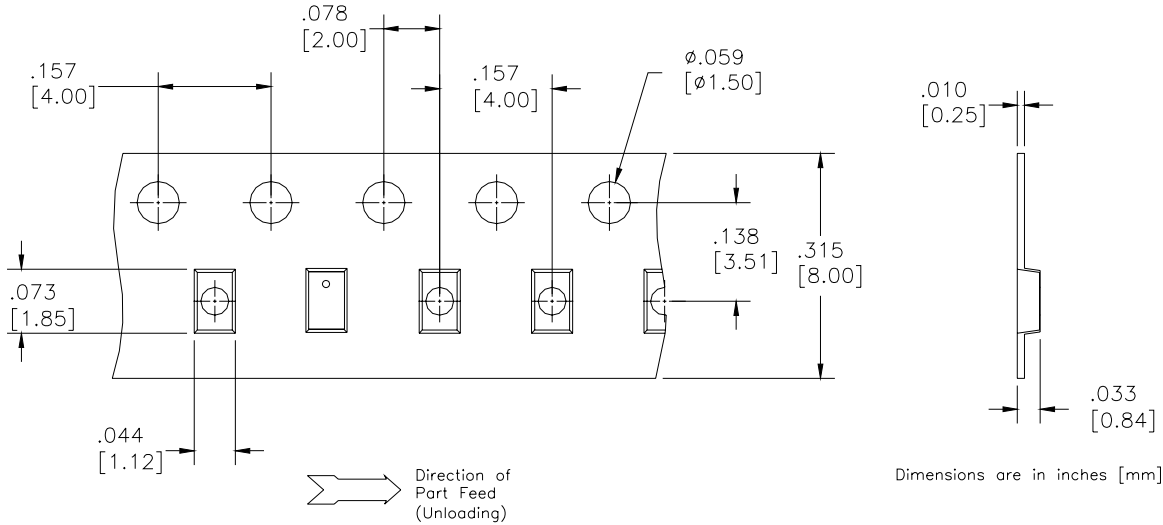

USA/Canada: (315) 432-8909  
 Toll Free: (800) 411-6596  
 Europe: +44 2392-232392

Available on Tape and Reel for Pick and Place Manufacturing.



# Anaren

What'll we think of next?™

# BD 2425 J 50 100 A 00

Function	Frequency	Package Dimensions	Unbalanced Impedance	Balanced Impedance + Coupling	Plating Finish	Codes
<b>B = Balun</b>	0110 = 100 – 1000 MHz	<b>A = 150 x 150 mils</b>	50 = 50 Ohm	25 = 25 Ω Balanced	A = Gold	
<b>BD = Balun + DC</b>	0810 = 800 – 1000 MHz	(4mm x 4mm)	75 = 75 Ohm	30 = 30 Ω Balanced	P = Tin-Lead	
<b>F = Filter</b>	0922 = 950 – 2150 MHz	<b>C = 120 x 120 mils</b>		50 = 50 Ω Balanced		
<b>FB = Filter / Balun</b>	0826 = 800 – 6200 MHz	(3mm x 3mm)		75 = 75 Ω Balanced		
<b>C = 3dB Coupler</b>	1222 = 1200 – 2200 MHz	<b>E = 100 x 80 mils</b>		100 = 100 Ω Balanced		
<b>DC = Directional</b>	1416 = 1400 – 1600 MHz	(2.5mm x 2mm)		150 = 150 Ω Balanced		
<b>J = RF Jumper</b>	1722 = 1700 – 2200 MHz	<b>J = 80 x 50 mils</b>		200 = 200 Ω Balanced		
<b>X = RF cross over</b>	2326 = 2300 – 2600 MHz	(2mm x 1.25mm)		300 = 300 Ω Balanced		
	2425 = 2400 – 2500 MHz	<b>L = 60 x 30 mils</b>		400 = 400 Ω Balanced		
	3150 = 3100 – 5000 MHz	(1.5mm x 0.75mm)		03 = 3dB Hybrid		
	3436 = 3400 – 3600 MHz	<b>N = 40 x 40 mils</b>		10 = 10dB Directional		
	4859 = 4800 – 5900MHz	(1mm x 1mm)		20 = 20dB Directional		
	5153 = 5100 – 5300 MHz					
	5159 = 5100 – 5900 MHz					
	5759 = 5700 – 5900 MHz					

