

# Xinger®

## Ultra Low Profile 0805 Balun 50Ω to 50Ω Balanced

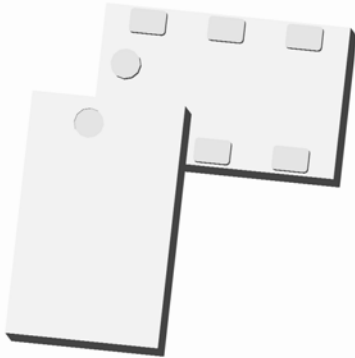

### Description

The BD2425J5050A00 is a low profile sub-miniature balanced to unbalanced transformer designed for differential inputs and output locations on next generation wireless chipsets in an easy to use surface mount package covering 802.11b+g+n. The BD2425J5050A00 is ideal for high volume manufacturing and is higher performance than traditional ceramic and lumped element baluns. The BD2425J5050A00 has an unbalanced port impedance of 50Ω and a 50Ω balanced port impedance. This transformation enables single ended signals to be applied to differential ports on modern semiconductors. The output ports have equal amplitude (-3dB) with 180 degree phase differential. The BD2425J5050A00 is available on tape and reel for pick and place high volume manufacturing.

### Detailed Electrical Specifications: Specifications subject to change without notice.

Features:	Parameter	ROOM (25°C)			Unit
		Min.	Typ.	Max	
<ul style="list-style-type: none"> <li>• 2400 – 2400 MHz</li> <li>• 0.7mm Height Profile</li> <li>• 50 Ohm to 2 x 25 Ohm</li> <li>• 802.11 b+g +n Compliant</li> <li>• Low Insertion Loss</li> <li>• Input to Output DC Isolation</li> <li>• Surface Mountable</li> <li>• Tape &amp; Reel</li> <li>• Non-conductive Surface</li> <li>• RoHS Compliant</li> </ul>	Frequency	2400		2500	MHz
	Unbalanced Port Impedance		50		Ω
	Balanced Port Impedance		50		Ω
	Return Loss	14	17		dB
	Insertion Loss*		0.8	0.9	dB
	Amplitude Balance		0.35	0.5	dB
	Phase Balance		1	5	Degrees
	CMRR				dB
	Power Handling			0.5	Watts
	Thermal Resistance			TBD	°C / Watt
	Operating Temperature	-55		+85	°C

\* Insertion Loss stated at room temperature (Insertion Loss is approximately 0.1 dB higher at +85 °C)

### Outline Drawing

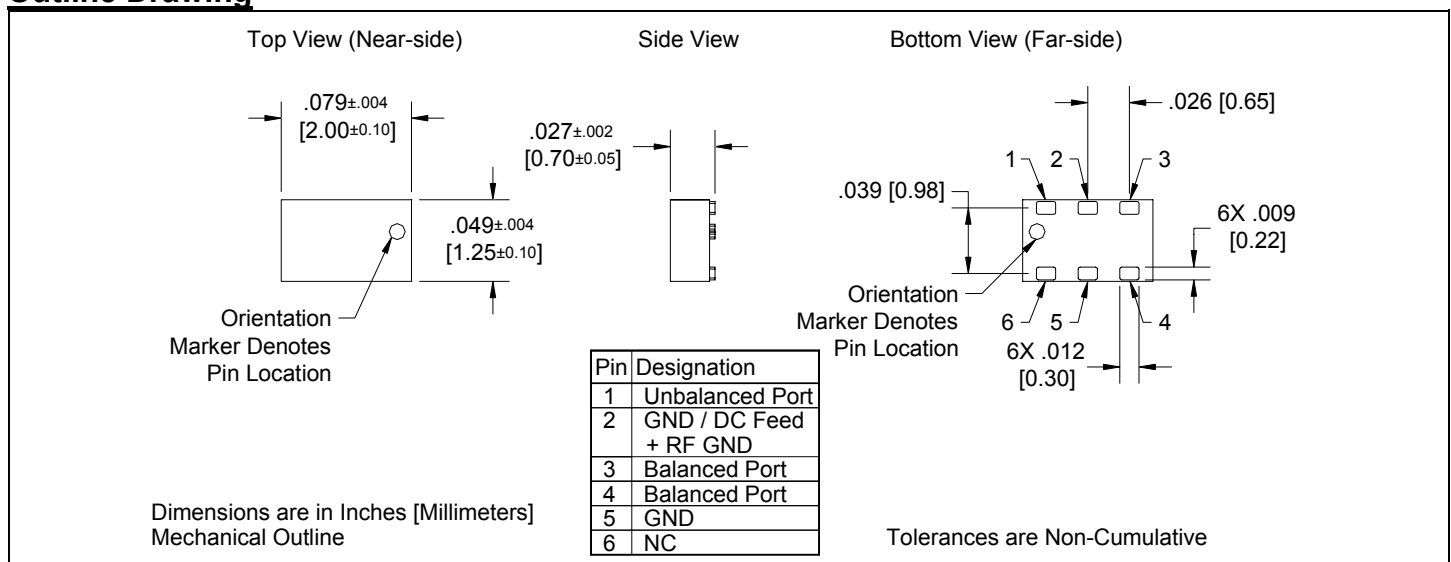

## Typical Broadband Performance: 0 GHz. to 6.0 GHz.

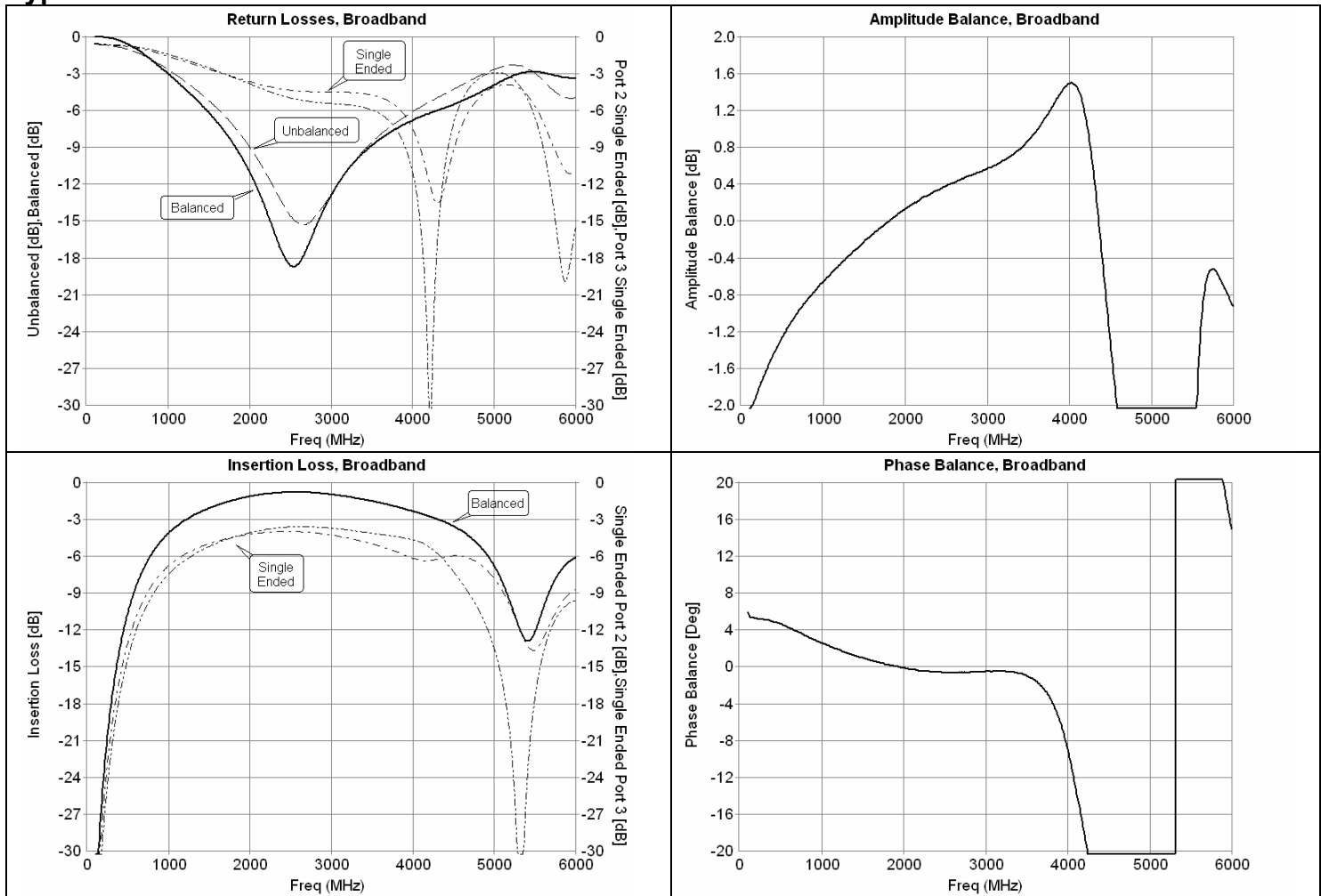

USA/Canada: (315) 432-8909  
 Toll Free: (800) 411-6596  
 Europe: +44 2392-232392

Available on Tape and Reel for Pick and Place Manufacturing.



# Anaren

What'll we think of next?™

### Typical Performance: 2400 MHz. to 2500 MHz.

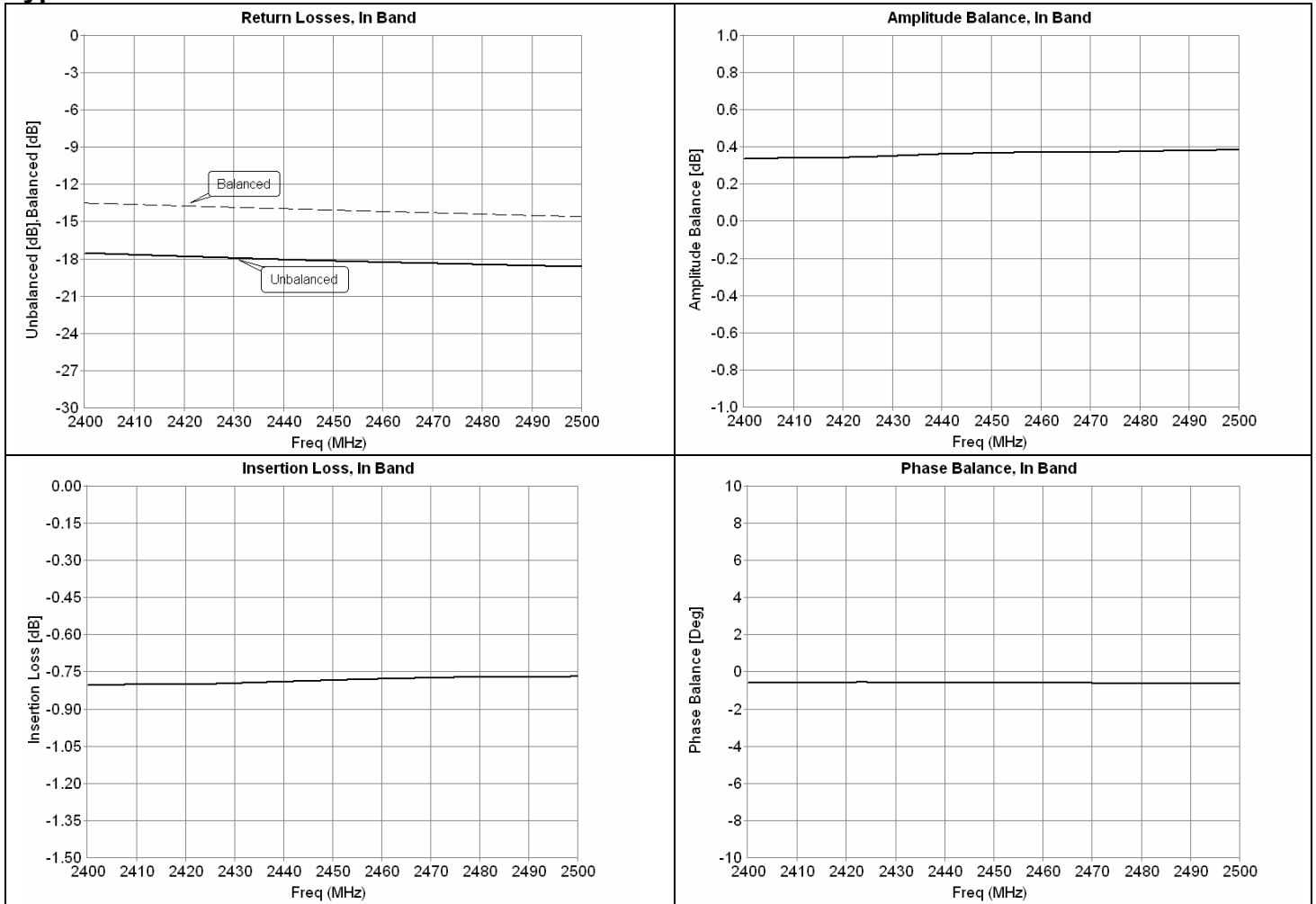

## Mounting Configuration:

In order for Xinger surface mount components to work optimally, the proper impedance transmission lines must be used to connect to the RF ports. If this condition is not satisfied, insertion loss, Isolation and VSWR may not meet published specifications.

All of the Xinger components are constructed from ceramic filled PTFE composites which possess excellent electrical and mechanical stability having X and Y thermal coefficient of expansion (CTE) of 17 ppm/°C.

An example of the PCB footprint used in the testing of these parts is shown below. An example of a DC-biased footprint is also shown below. In specific designs, the transmission line widths need to be adjusted to the unique dielectric coefficients and thicknesses as well as varying pick and place equipment tolerances.

### No Bias Footprint

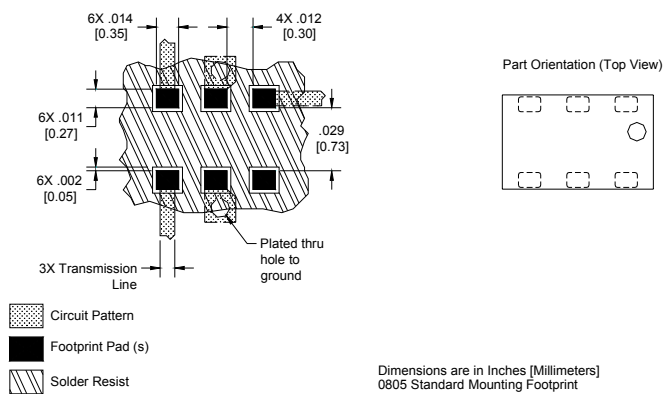

### DC Bias Footprint

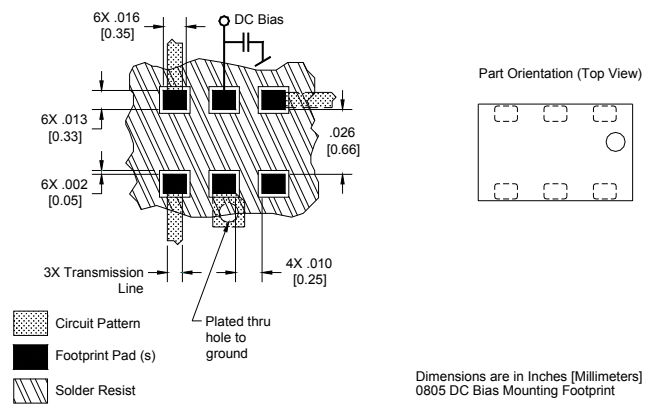

### Packaging and Ordering Information

Parts are available in reel and are packaged per EIA 481-2. Parts are oriented in tape and reel as shown below. Minimum order quantities are 4000 per reel. See Model Numbers below for further ordering information.

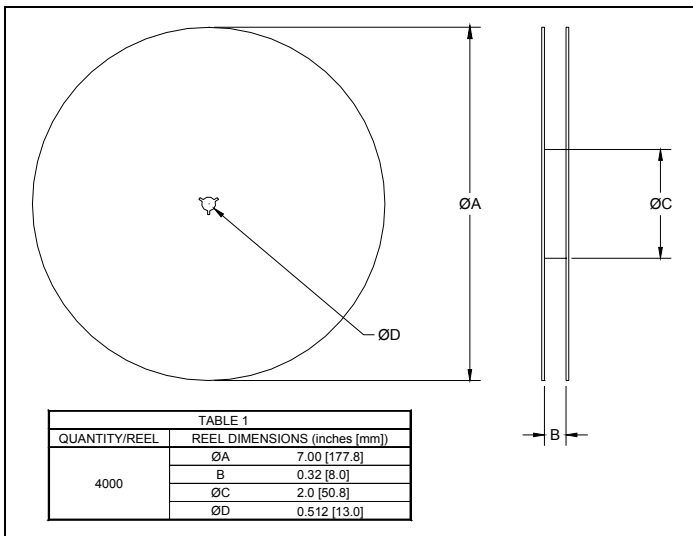
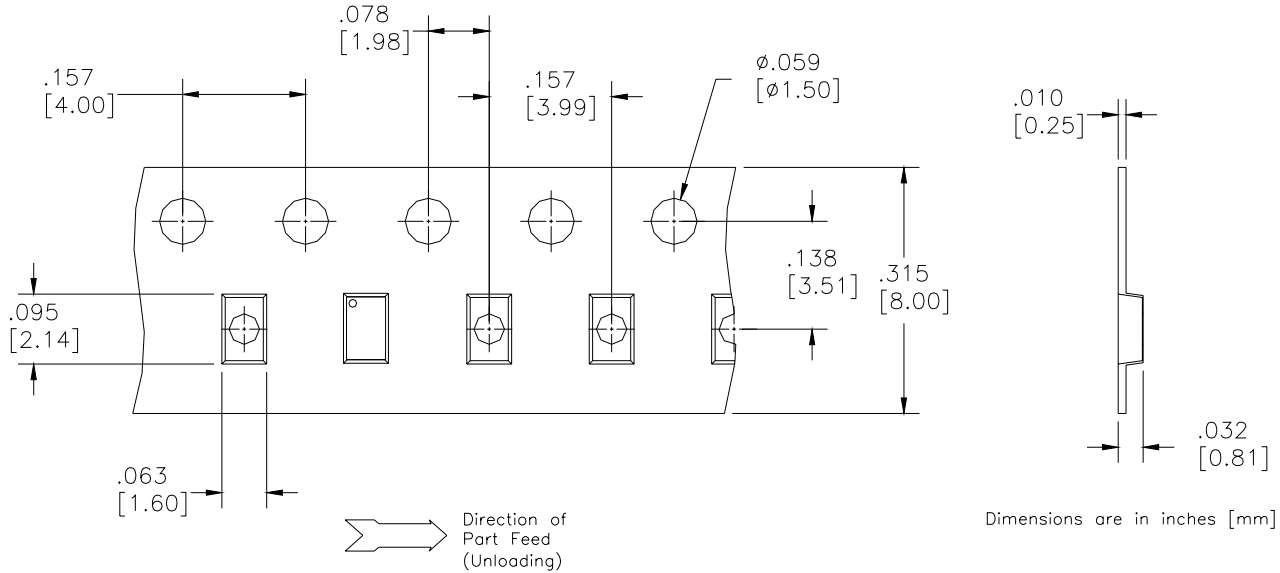

# BD 2425 J 50 100 A 00

Function	Frequency	Package Dimensions	Unbalanced Impedance	Balanced Impedance + Coupling	Plating Finish	Codes
<b>B = Balun</b> <b>BD = Balun + DC</b> <b>F = Filter</b> <b>FB = Filter / Balun</b> <b>C = 3dB Coupler</b> <b>DC = Directional</b> <b>J = RF Jumper</b> <b>X = RF cross over</b>	0110 = 100 – 1000 MHz	<b>A = 150 x 150 mils</b> (4mm x 4mm)	50 = 50 Ohm	25 = 25 Ω Balanced	<b>A = Gold</b> <b>P = Tin-Lead</b>	
	0810 = 800 – 1000 MHz	<b>C = 120 x 120 mils</b> (4mm x 4mm)	75 = 75 Ohm	30 = 30 Ω Balanced		
	0922 = 950 – 2150 MHz	<b>D = 126 x 79 mils</b> (3.2mm x 2mm)		50 = 50 Ω Balanced		
	0826 = 800 – 6200 MHz	<b>E = 100 x 80 mils</b> (3mm x 2mm)		75 = 75 Ω Balanced		
	1222 = 1200 – 2200 MHz	<b>G = 120 x 60 mils</b> (3mm x 1.5mm)		100 = 100 Ω Balanced		
	1416 = 1400 – 1600 MHz	<b>J = 80 x 50 mils</b> (2mm x 1.25mm)		150 = 150 Ω Balanced		
	1722 = 1700 – 2200 MHz	<b>K = 90 x 60 mils</b> (2.25mm x 1.5mm)		200 = 200 Ω Balanced		
	2326 = 2300 – 2600 MHz	<b>L = 60 x 30 mils</b> (1.5mm x 0.75mm)		300 = 300 Ω Balanced		
	2425 = 2400 – 2500 MHz	<b>N = 140 x 80 mils</b> (3.5mm x 2mm)		400 = 400 Ω Balanced		
	3150 = 3100 – 5000 MHz			03 = 3dB Hybrid		
	3436 = 3400 – 3600 MHz			10 = 10dB Directional		
	4859 = 4800 – 5900MHz			20 = 20dB Directional		
	5153 = 5100 – 5300 MHz					
	5159 = 5100 – 5900 MHz					
5759 = 5700 – 5900 MHz						

USA/Canada: (315) 432-8909  
 Toll Free: (800) 411-6596  
 Europe: +44 2392-232392

Available on Tape and Reel for Pick and Place Manufacturing.



**Anaren**

What'll we think of next?™