

Xinger®

Ultra Small Low Profile 0603 Balun 50Ω to 200Ω Balanced

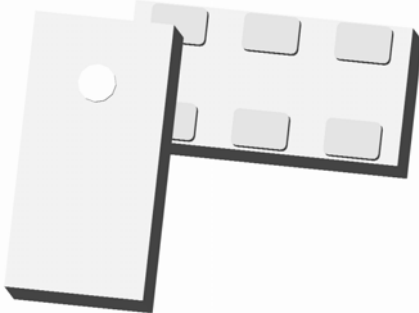

Description

The BD3150L50200A00 is an ultra-small low profile balanced to unbalanced transformer designed for differential inputs and output locations on next generation wireless chipsets in an easy to use surface mount package covering the MMDS and the low end of the UWB frequency ranges. The BD3150L50200A00 is ideal for high volume manufacturing and is higher performance than traditional ceramic baluns. The BD3150L50200A00 has an unbalanced port impedance of 50Ω and a 200Ω balanced port impedance. This transformation enables single ended signals to be applied to differential ports on modern integrated chipsets. The output ports have equal amplitude (-3dB) with 180 degree phase differential. The BD3150L50200A00 is available on tape and reel for pick and place high volume manufacturing.

Detailed Electrical Specifications: Specifications subject to change without notice.

Features:	Parameter	ROOM (25°C)			Unit
		Min.	Typ.	Max	
<ul style="list-style-type: none"> • 3100 – 5000 MHz • 0.7mm Height Profile • 50 Ohm to 2 x 100 Ohm • UWB & MMDS • Low Insertion Loss • Input to Output DC Isolation • Surface Mountable • Tape & Reel • Non-conductive Surface • RoHS Compliant 	Frequency	3100		5000	MHz
	Unbalanced Port Impedance		50		Ω
	Balanced Port Impedance		200		Ω
	Return Loss	11	14		dB
	Insertion Loss*		0.9	1.2	dB
	Amplitude Balance		0.7	1.3	dB
	Phase Balance		5	11	Degrees
	CMRR		25		dB
	Power Handling			0.5	Watts
	Operating Temperature	-55		+85	°C

* Insertion Loss stated at room temperature (Insertion Loss is approximately 0.1 dB higher at +85 °C)

Outline Drawing

Top View (Near-side)

Side View

Bottom View (Far-side)

Pin	Designation
1	Unbalanced Port
2	DC Bias/GND
3	Balanced Port
4	Balanced Port
5	GND
6	GND

Dimensions are in Inches [Millimeters]
Mechanical Outline

Tolerances are Non-Cumulative



Typical Broadband Performance: 500 MHz. to 8500 MHz.

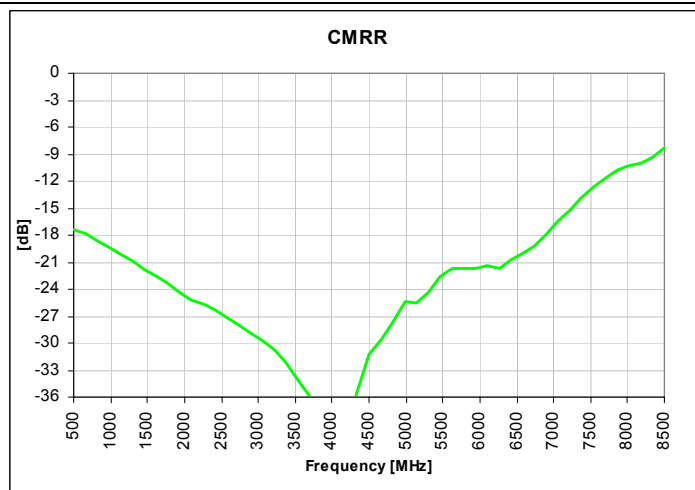
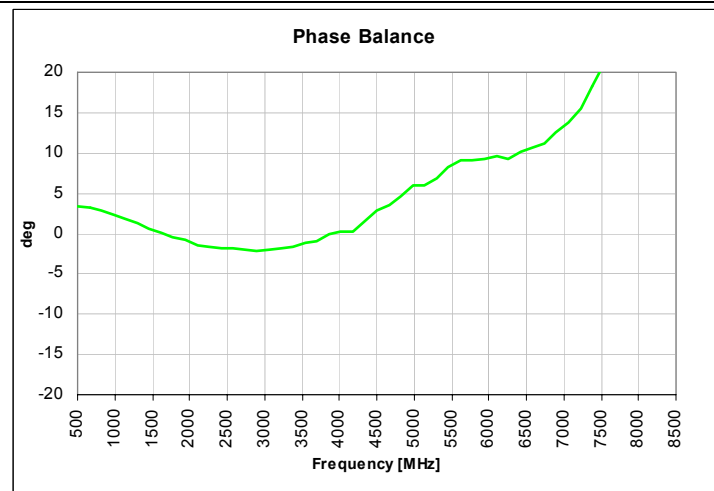
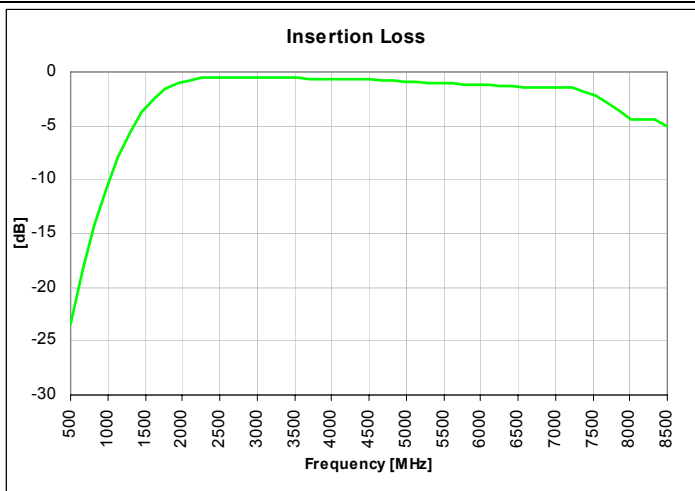
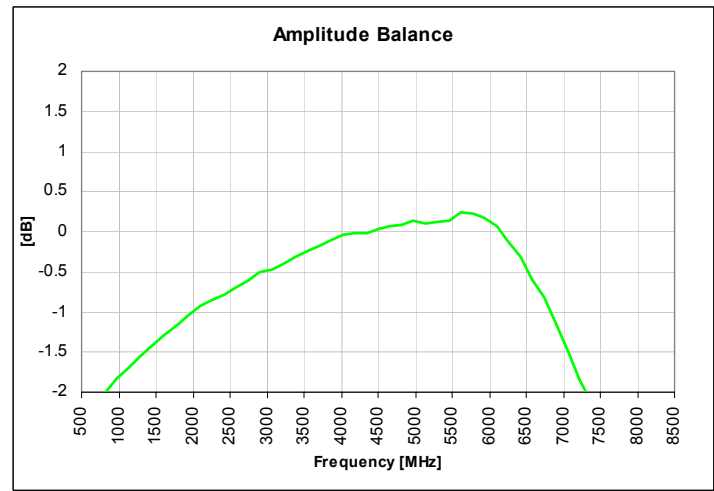
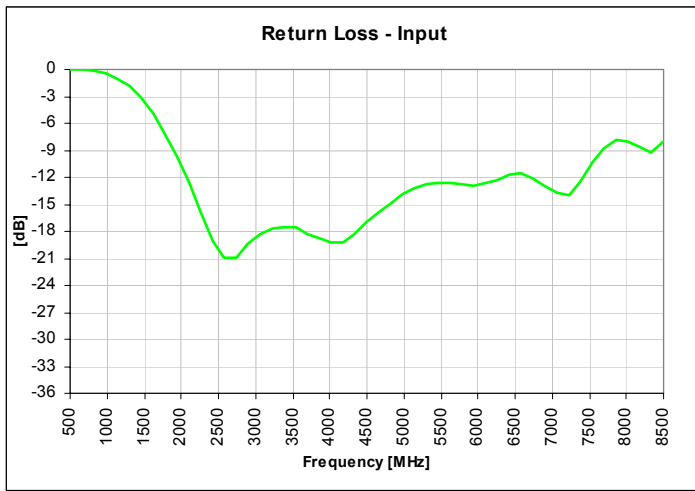

Typical Performance: 3000 MHz. to 5100 MHz.

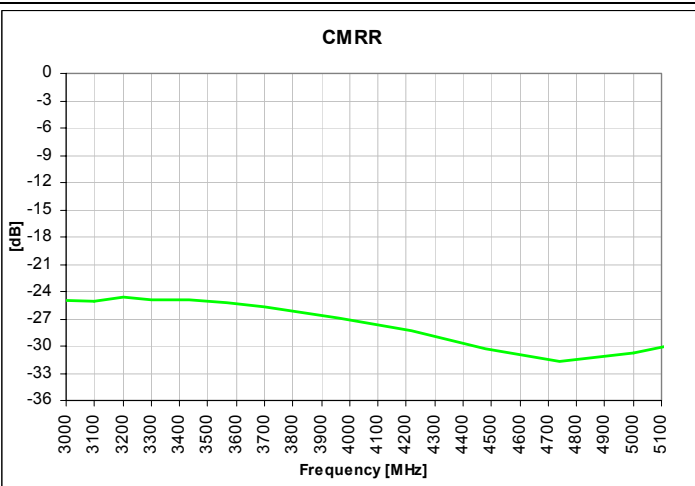
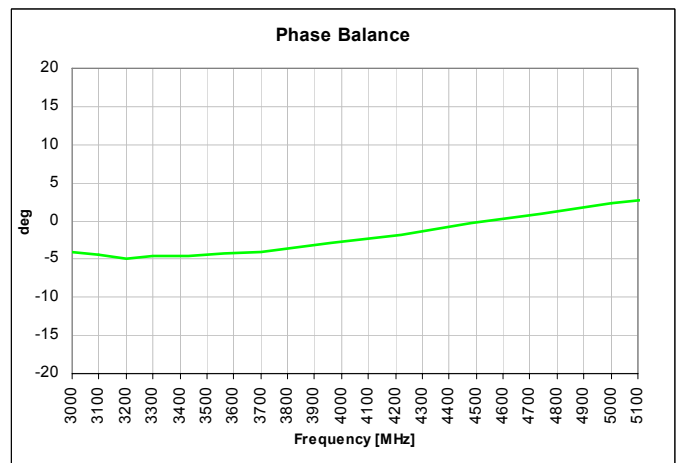
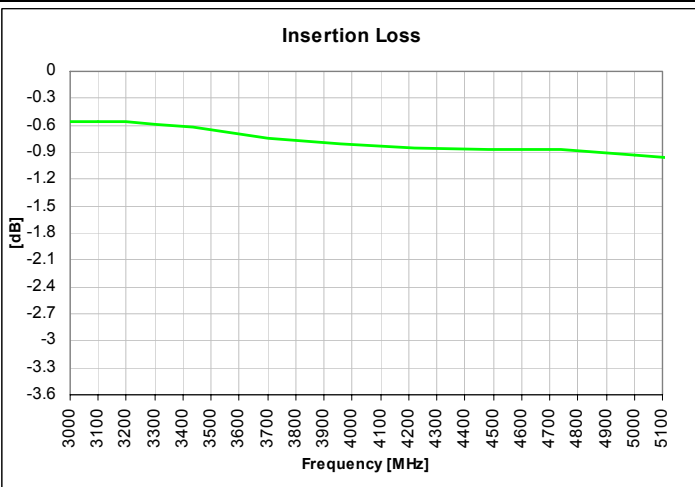
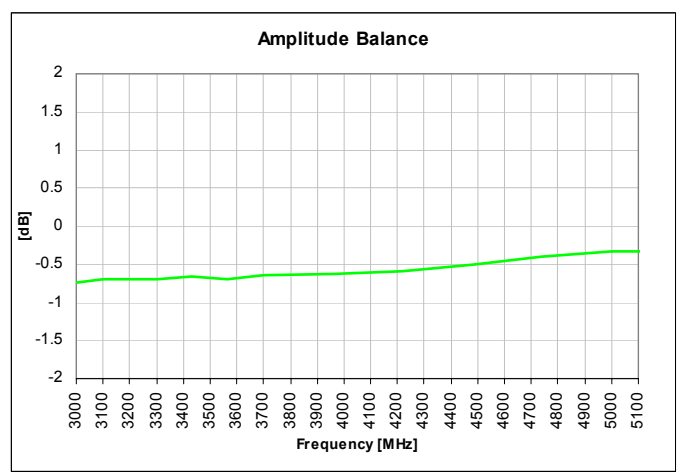
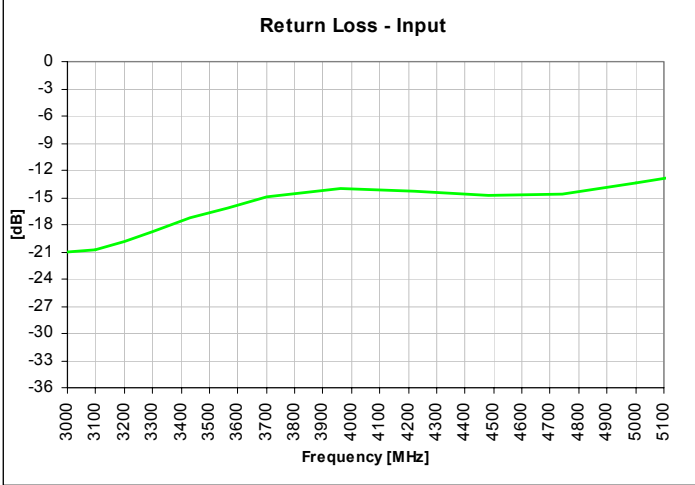

Mounting Configuration:

In order for Xinger surface mount components to work optimally, the proper impedance transmission lines must be used to connect to the RF ports. If this condition is not satisfied, insertion loss, Isolation and VSWR may not meet published specifications.

All of the Xinger components are constructed from ceramic filled PTFE composites which possess excellent electrical and mechanical stability having X and Y thermal coefficient of expansion (CTE) of 17 ppm/°C.

An example of the PCB footprint used in the testing of these parts is shown below. An example of a DC-biased footprint is also shown below. In specific designs, the transmission line widths need to be adjusted to the unique dielectric coefficients and thicknesses as well as varying pick and place equipment tolerances.

No Bias Footprint

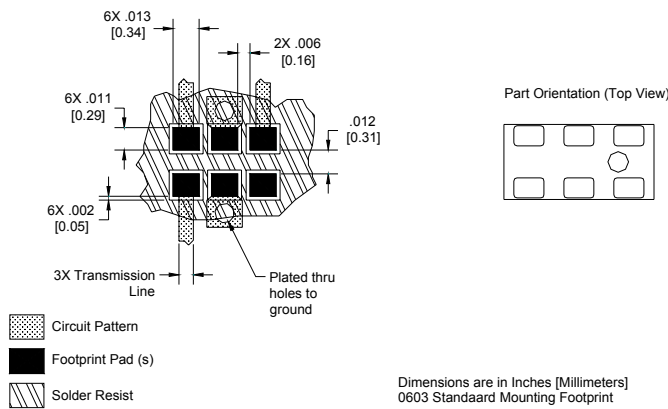

DC Bias Footprint

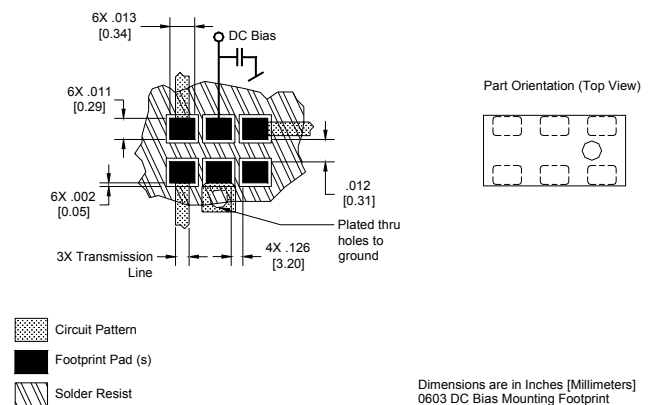

Packaging and Ordering Information

Parts are available in reel and are packaged per EIA 481-2. Parts are oriented in tape and reel as shown below. Minimum order quantities are 4000 per reel. See Model Numbers below for further ordering information.

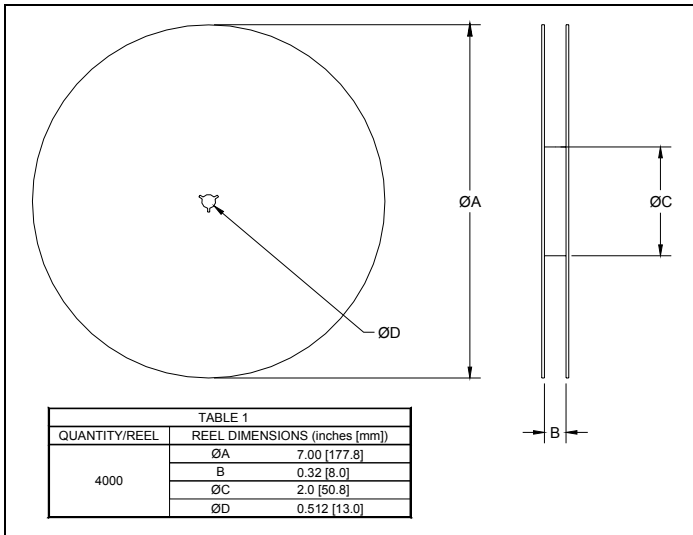
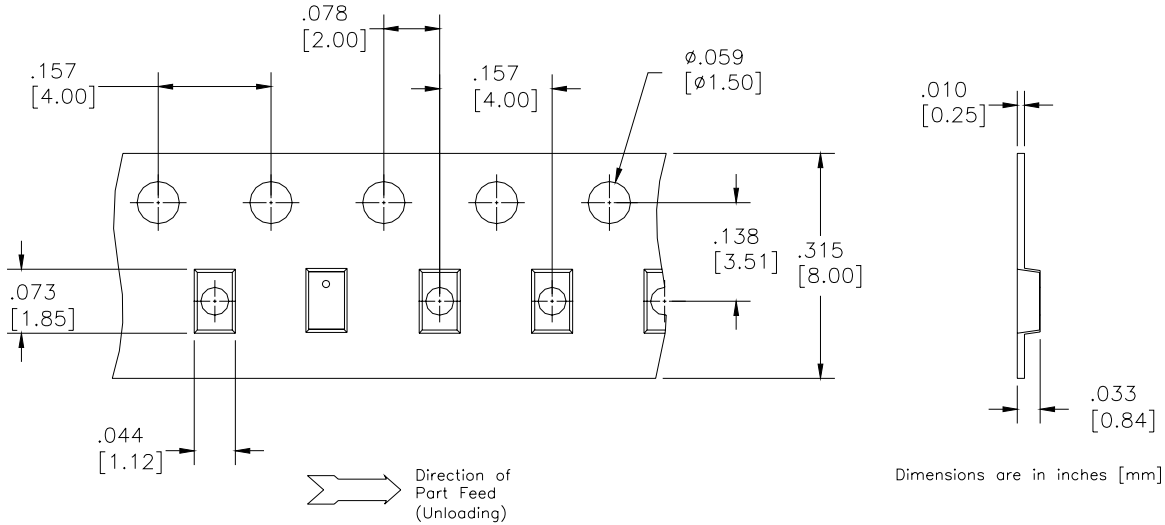

BD 2425 J 50 100 A 00

Function	Frequency	Package Dimensions	Unbalanced Impedance	Balanced Impedance + Coupling	Plating Finish	Codes
B = Balun	0110 = 100 – 1000 MHz	A = 150 x 150 mils	50 = 50 Ohm	25 = 25 Ω Balanced	A = Gold	
BD = Balun + DC	0810 = 800 – 1000 MHz	(4mm x 4mm)	75 = 75 Ohm	30 = 30 Ω Balanced	P = Tin-Lead	
F = Filter	0922 = 950 – 2150 MHz	C = 120 x 120 mils		50 = 50 Ω Balanced		
FB = Filter / Balun	0826 = 800 – 6200 MHz	(3mm x 3mm)		75 = 75 Ω Balanced		
C = 3dB Coupler	1222 = 1200 – 2200 MHz	E = 100 x 80 mils		100 = 100 Ω Balanced		
DC = Directional	1416 = 1400 – 1600 MHz	(2.5mm x 2mm)		150 = 150 Ω Balanced		
J = RF Jumper	1722 = 1700 – 2200 MHz	J = 80 x 50 mils		200 = 200 Ω Balanced		
X = RF cross over	2326 = 2300 – 2600 MHz	(2mm x 1.25mm)		300 = 300 Ω Balanced		
	2425 = 2400 – 2500 MHz	L = 60 x 30 mils		400 = 400 Ω Balanced		
	3150 = 3100 – 5000 MHz	(1.5mm x 0.75mm)		03 = 3dB Hybrid		
	3436 = 3400 – 3600 MHz	N = 40 x 40 mils		10 = 10dB Directional		
	4859 = 4800 – 5900MHz	(1mm x 1mm)		20 = 20dB Directional		
	5153 = 5100 – 5300 MHz					
	5159 = 5100 – 5900 MHz					
	5759 = 5700 – 5900 MHz					

USA/Canada: (315) 432-8909
 Toll Free: (800) 411-6596
 Europe: +44 2392-232392

Available on Tape and Reel for Pick and Place Manufacturing.



Anaren

What'll we think of next?™