

Top View (Near-Side)

Side View

Bottom View (Far-Side)

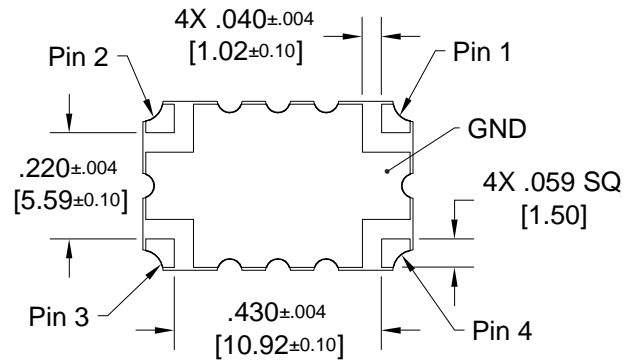
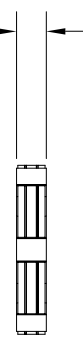
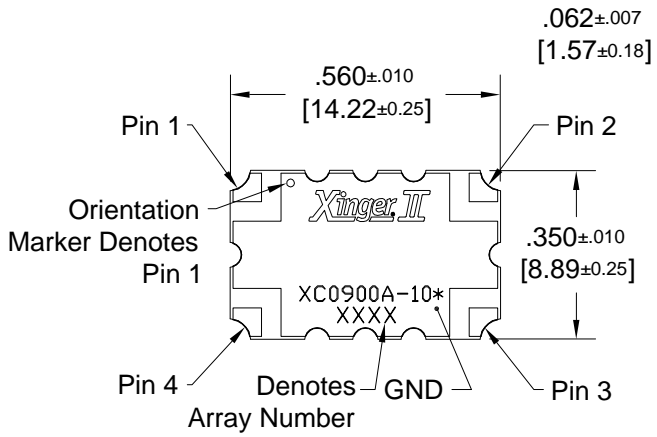

Dimensions are in Inches [Millimeters]  
XC0900A-10\* Mechanical Outline

Tolerances are Non-Cumulative  
\* = Plating Finish