

Top View (Near-Side)

Side View

Bottom View (Far-Side)

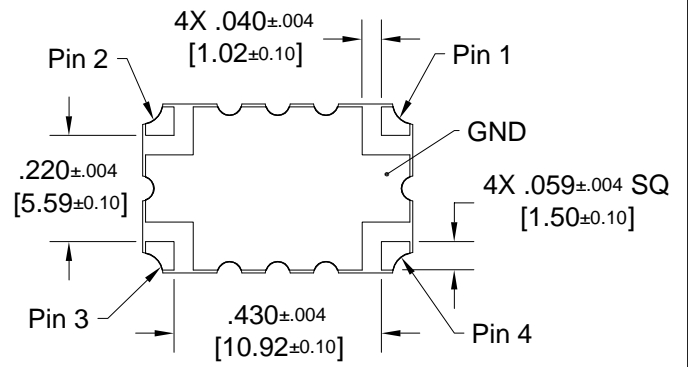
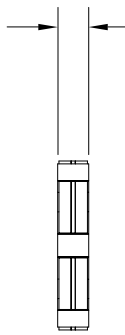
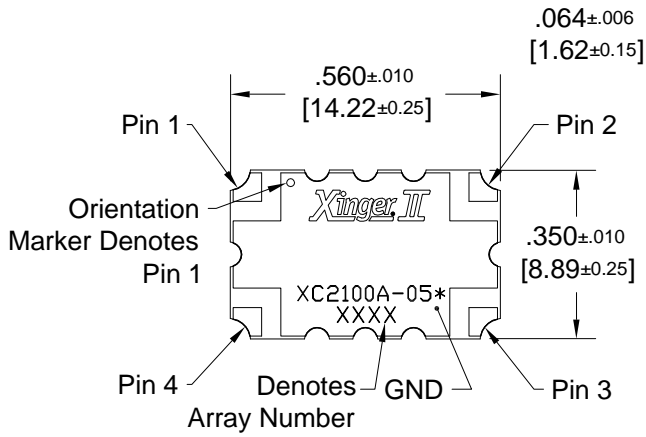

Dimensions are in Inches [Millimeters]
XC2100A-05* Mechanical Outline

Tolerances are Non-Cumulative
* = Plating Finish