

Top View (Near-Side)

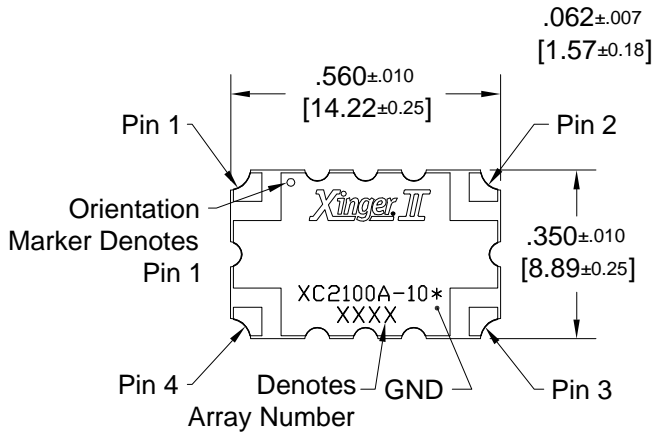

Side View

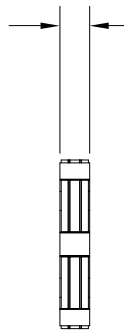

Bottom View (Far-Side)

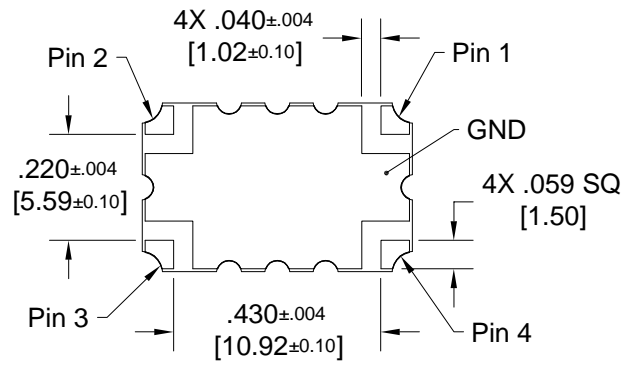

Dimensions are in Inches [Millimeters]
XC2100A-10* Mechanical Outline

Tolerances are Non-Cumulative
* = Plating Finish