

# Synchronous Rectifier Driver for Forward Converters

November 2003

## FEATURES

- N-Channel Synchronous Rectifier MOSFET Driver
- Programmable Timeout
- Reverse Inductor Current Sense
- Pulse Transformer Synchronization
- Wide  $V_{CC}$  supply range: 4.5V to 11V
- 15ns Rise/Fall Times at  $V_{CC} = 5V$ ,  $C_L = 4700pF$
- Undervoltage Lockout
- Small SO-8 Package

## APPLICATIONS

- 48V Input Isolated DC/DC Converters
- Isolated Telecom Power Supplies
- Distributed Power Step-Down Converters
- Industrial Control System Power Supplies
- Automotive and Heavy Equipment

## DESCRIPTION

The LTC<sup>®</sup>3900 is a secondary-side synchronous rectifier driver designed to be used in isolated forward converter power supplies. The chip drives N-channel rectifier MOSFETs and accepts pulse synchronization from the primary-side controller via a pulse transformer.

The LTC3900 incorporates a full range of protection for the external MOSFETs. A programmable timeout function is included that disables both drivers when the synchronization signal is missing or incorrect. Additionally, the chip senses the output inductor current through the drain-source resistance of the catch MOSFET, shutting off the MOSFET if the inductor current reverses. The LTC3900 also shuts off the drivers if the supply voltage is low.

LT, LTC and LT are registered trademarks of Linear Technology Corporation.

## TYPICAL APPLICATION

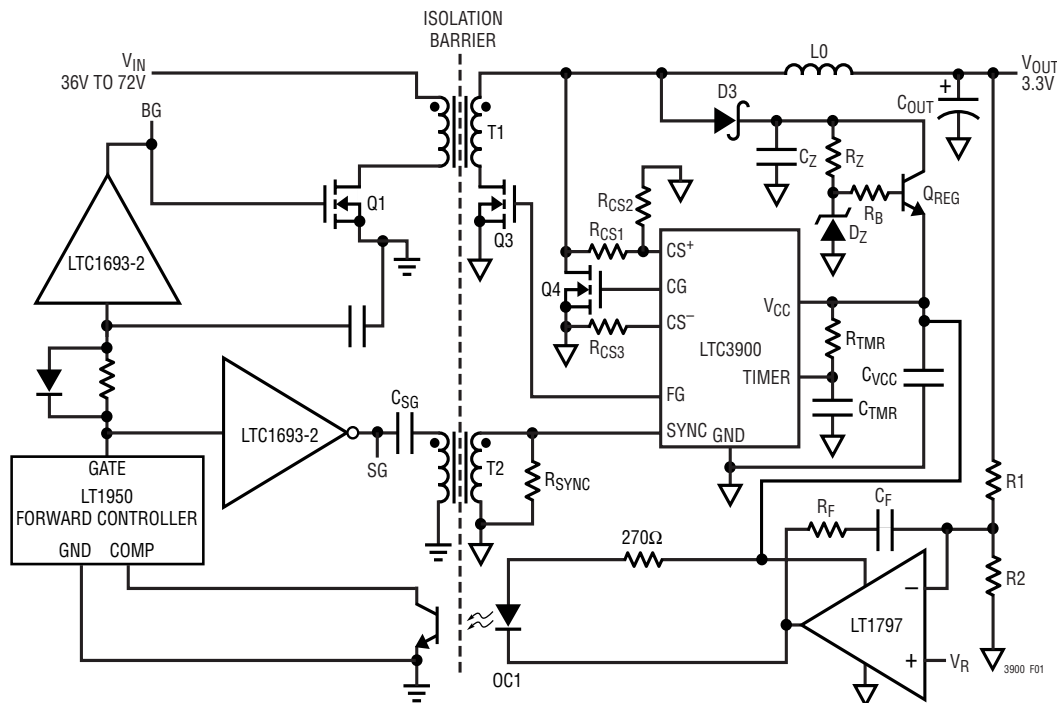

Figure 1. Simplified Isolated Forward Converter

## ABSOLUTE MAXIMUM RATINGS

(Note 1)

Supply Voltage

$V_{CC}$  ..... 12V

Input Voltage

$CS^-$ , TIMER .....  $-0.3V$  to  $(V_{CC} + 0.3V)$

SYNC .....  $-12V$  to  $12V$

Input Current

$CS^+$  ..... 15mA

Operating Temperature Range (Note 2) ...  $-40^{\circ}C$  to  $85^{\circ}C$

Storage Temperature Range .....  $-65^{\circ}C$  to  $150^{\circ}C$

Lead Temperature (Soldering, 10 sec) .....  $300^{\circ}C$

## PACKAGE/ORDER INFORMATION

<p>S8 PACKAGE 8-LEAD PLASTIC SO <math>T_{JMAX} = 150^{\circ}C</math>, <math>\theta_{JA} = 130^{\circ}C/W</math></p>	ORDER PART NUMBER
	LTC3900ES8
	S8 PART MARKING
	3900

Consult LTC Marketing for parts specified with wider operating temperature ranges.

## ELECTRICAL CHARACTERISTICS

The ● denotes specifications which apply over the full operating temperature range.  $V_{CC} = 5V$ ,  $T_A = 25^{\circ}C$  unless otherwise specified. (Note 3)

SYMBOL	PARAMETER	CONDITIONS	MIN	TYP	MAX	UNITS
$V_{CC}$	Supply Voltage Range	●	4.5	5	11	V
$V_{UVLO}$	$V_{CC}$ Undervoltage Lockout Threshold	Rising Edge	●	4.1	4.5	V
	$V_{CC}$ Undervoltage Lockout Hysteresis	Rising Edge to Falling Edge		0.5		V
$I_{VCC}$	$V_{CC}$ Supply Current	$V_{SYNC} = 0V$	●	0.5	1	mA
		$f_{SYNC} = 100kHz$ , $C_{FG} = C_{CG} = 4700pF$ (Note 4)	●	7	15	mA
<b>Timer</b>						
$V_{TMR}$	Timer Threshold Voltage	●	-10%	$V_{CC}/5$	10%	V
$I_{TMR}$	Timer Input Current	$V_{TMR} = 0V$	●	-6	-10	$\mu A$
$t_{TMRDIS}$	Timer Discharge Time	$C_{TMR} = 1000pF$ , $R_{TMR} = 4.7k$	●	40	120	ns
$V_{TMRMAX}$	Timer Pin Clamp Voltage	$C_{TMR} = 1000pF$ , $R_{TMR} = 4.7k$		2.5		V
<b>Current Sense</b>						
$I_{CS+}$	$CS^+$ Input Current	$V_{CS+} = 0V$	●		$\pm 1$	$\mu A$
$I_{CS-}$	$CS^-$ Input Current	$V_{CS-} = 0V$	●		$\pm 1$	$\mu A$
$V_{CSMAX}$	$CS^+$ Pin Clamp Voltage	$I_{IN} = 5mA$ , $V_{SYNC} = -5V$		11		V
$V_{CS}$	Current Sense Threshold Voltage	$V_{CS-} = 0V$ (Note 6)	●	7.5 3	10.5 18	mV mV
<b>SYNC Input</b>						
$I_{SYNC}$	SYNC Input Current	$V_{SYNC} = \pm 10V$	●	$\pm 1$	$\pm 10$	$\mu A$
$V_{SYNCP}$	SYNC Input Positive Threshold	(Note 5)	●	1.0	1.4	V
	SYNC Positive Input Hysteresis	(Note 5)		0.2		V
$V_{SYNCP}$	SYNC Input Negative Threshold	(Note 5)	●	-1.8	-1.4	V
	SYNC Negative Input Hysteresis	(Note 5)		0.2	-1.0	V

**ELECTRICAL CHARACTERISTICS** The ● denotes specifications which apply over the full operating temperature range.  $V_{CC} = 5V$ ,  $T_A = 25^\circ C$  unless otherwise specified. (Note 3)

SYMBOL	PARAMETER	CONDITIONS	MIN	TYP	MAX	UNITS
<b>Driver Output</b>						
$R_{ONH}$	Driver Pull-Up Resistance	$I_{OUT} = -100mA$	●	0.9	1.2	$\Omega$
$R_{ONL}$	Driver Pull-Down Resistance	$I_{OUT} = 100mA$	●	0.9	1.2	$\Omega$
$I_{PK}$	Driver Peak Output Current	(Note 5)		2		A
<b>Switching Characteristics (Note 7)</b>						
$t_d$	SYNC Input to Driver Output Delay	$C_{FG} = C_{CG} = 4700pF$ , $V_{SYNC} = \pm 5V$	●	60	120	ns
$t_{SYNC}$	Minimum SYNC Pulse Width	$V_{SYNC} = \pm 5V$	●	75		ns
$t_r$ , $t_f$	Driver Rise/Fall Time	$C_{FG} = C_{CG} = 4700pF$ , $V_{SYNC} = \pm 5V$		15		ns

**Note 1:** Absolute Maximum Ratings are those values beyond which the life of a device may be impaired.

**Note 2:** The LTC3900E is guaranteed to meet performance specifications from  $0^\circ C$  to  $70^\circ C$ . Specifications over the  $-40^\circ C$  to  $85^\circ C$  operating temperature range are assured by design; characterization and correlation with statistical process controls.

**Note 3:** All currents into device pins are positive; all currents out of device pins are negative. All voltages are referenced to ground unless otherwise specified.

**Note 4:** Supply current in normal operation is dominated by the current needed to charge and discharge the external MOSFET gates. This current

will vary with supply voltage, switching frequency and the external MOSFETs used.

**Note 5:** Guaranteed by design, not subject to test.

**Note 6:** The current sense comparator threshold has a  $0.33\%/^\circ C$  temperature coefficient (TC) to match the TC of the external MOSFET  $R_{DS(ON)}$ .

**Note 7:** Rise and fall times are measured using 10% and 90% levels. Delay times are measured from  $\pm 1.4V$  at SYNC input to 20%/80% levels at the driver output.

**TYPICAL PERFORMANCE CHARACTERISTICS**

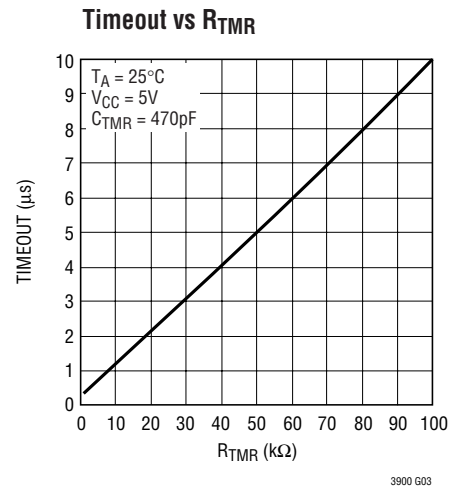
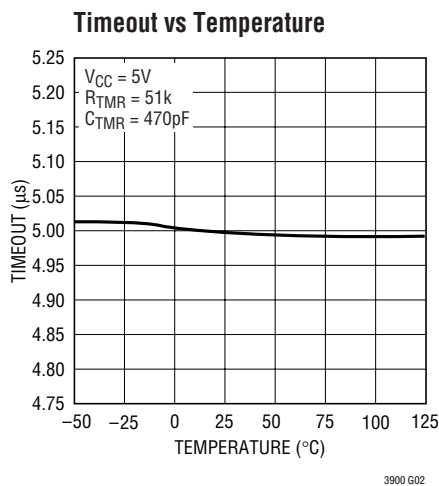
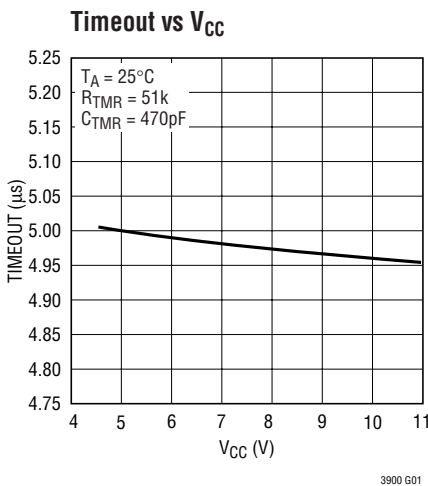

# TYPICAL PERFORMANCE CHARACTERISTICS

**Current Sense Threshold vs Temperature**

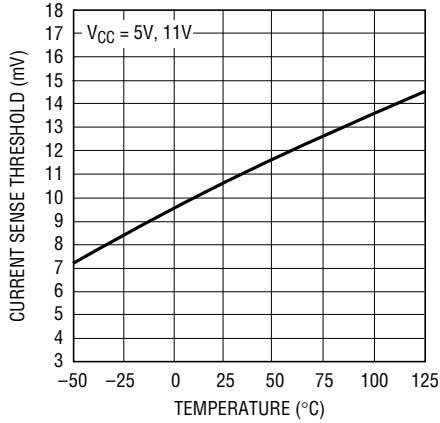

3900 G04

**$V_{CS(MAX)}$  Clamp Voltage vs  $CS^+$  Input Current**

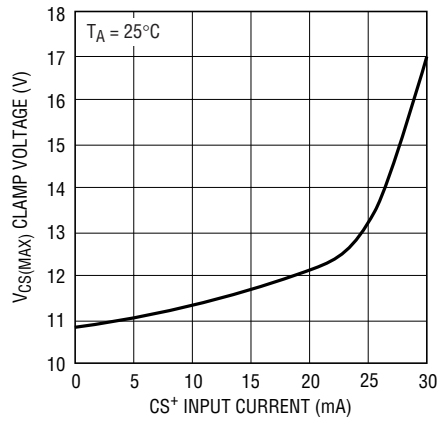

3900 G05

**SYNC Positive Threshold vs Temperature**

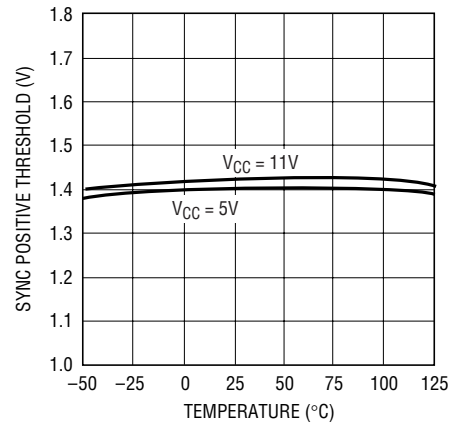

3900 G06

**SYNC Negative Threshold vs Temperature**

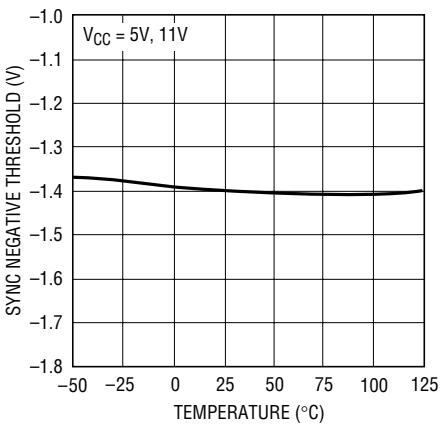

3900 G07

**Propagation Delay vs  $V_{CC}$**

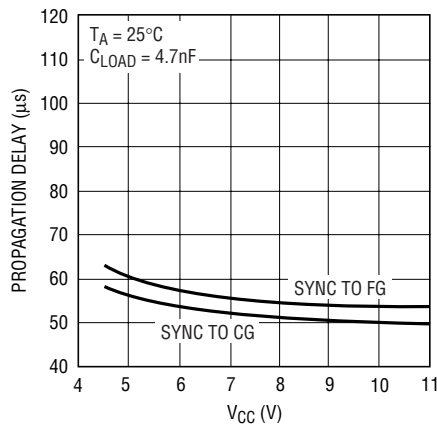

3900 G08

**Propagation Delay vs Temperature**

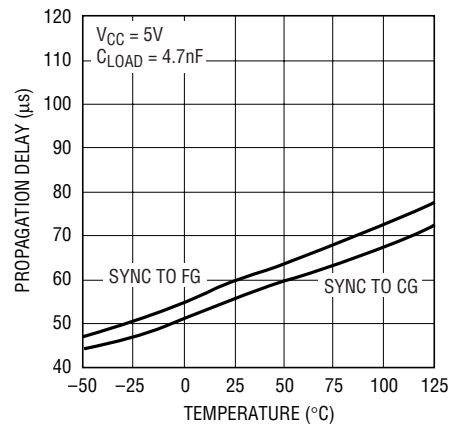

3900 G09

**Propagation Delay vs  $C_{LOAD}$**

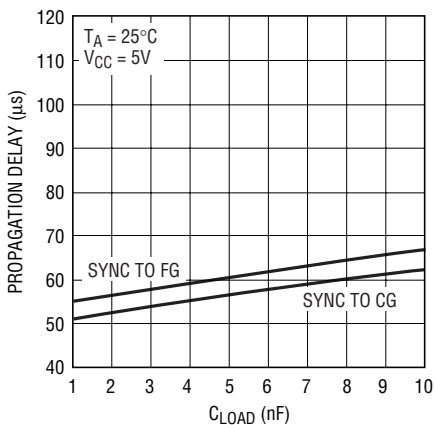

3900 G10

**Rise/Fall Time vs  $V_{CC}$**

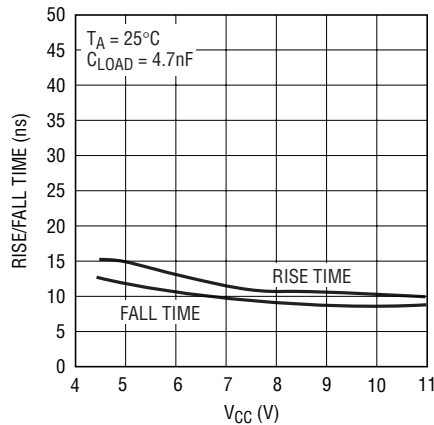

3900 G11

**Rise/Fall Time vs Temperature**

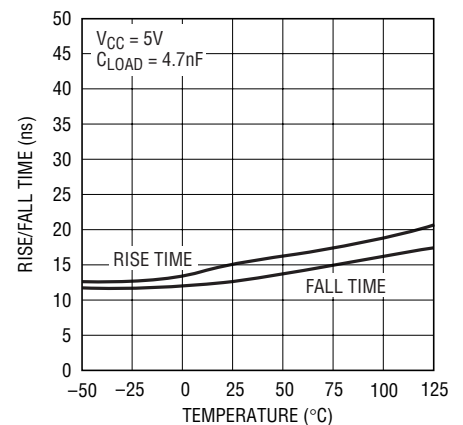

3900 G12

# TYPICAL PERFORMANCE CHARACTERISTICS

**Rise/Fall Time vs Load Capacitance**

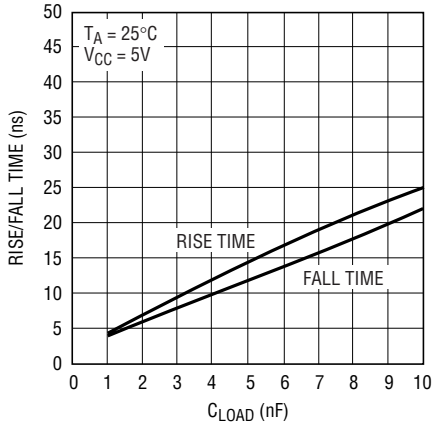

3900 G13

**Undervoltage Lockout Threshold Voltage vs Temperature**

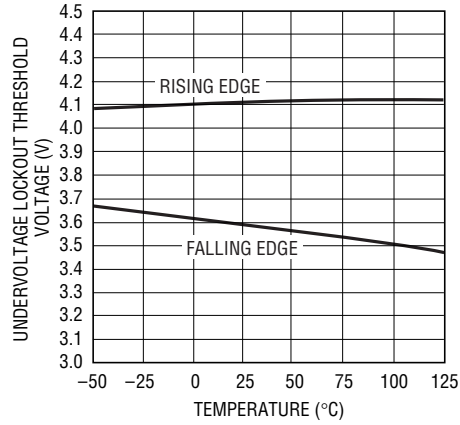

3900 G14

**V<sub>CC</sub> Supply Current vs Temperature**

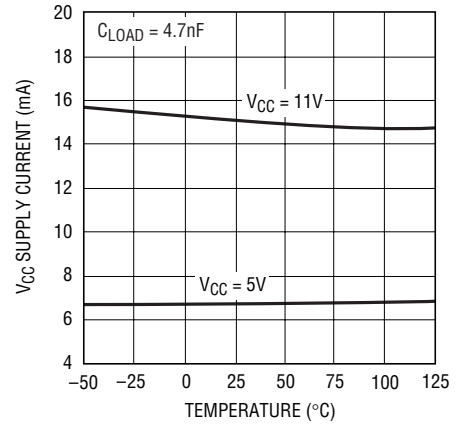

3900 G15

**V<sub>CC</sub> Supply Current vs Load Capacitance**

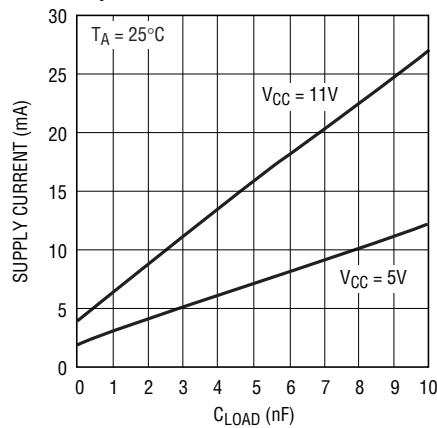

3900 G16

## PIN FUNCTIONS

**CS<sup>+</sup>, CS<sup>-</sup> (Pin 1, 2):** Current Sense Differential Input. Connect CS<sup>+</sup> through a series resistor to the drain of the external catch MOSFET, Q4. Connect CS<sup>-</sup> to the source. The LTC3900 monitors the CS inputs 250ns after CG goes high. If the inductor current reverses and flows into the MOSFET causing CS<sup>+</sup> to rise above CS<sup>-</sup> by more than 10.5mV, the LTC3900 pulls CG low. See the Current Sense section for more details on choosing the resistance value for R<sub>CS1</sub> to R<sub>CS3</sub>.

**CG (Pin 3):** Catch MOSFET Gate Driver. This pin drives the gate of the external N-channel catch MOSFET, Q4.

**V<sub>CC</sub> (Pin 4):** Main Supply Input. This pin powers the drivers and the rest of the internal circuitry. Bypass this pin to GND using a 4.7μF capacitor in close proximity to the LTC3900.

**FG (Pin 5):** Forward MOSFET Gate Driver. This pin drives the gate of the external N-channel forward MOSFET, Q3.

**GND (Pin 6):** The V<sub>CC</sub> bypass capacitor should be connected directly to this GND pin.

**TIMER (Pin 7):** Timer Input. Connect this pin to an external R-C network to program the timeout period. The LTC3900 resets the timer at every negative transition of the SYNC input. If the SYNC signal is missing or incorrect, the LTC3900 pulls both CG and FG low once the TIMER pin goes above the timeout threshold. See the Timer section for more details on programming the timeout period.

**SYNC (Pin 8):** Driver Synchronization Input. This input is signal edge sensitive. A negative voltage slew at SYNC forces FG to pull high and CG to pull low. A positive voltage slew at SYNC forces FG to pull low and CG to pull high. The SYNC input can accept both pulse or square wave signals.

## BLOCK DIAGRAM

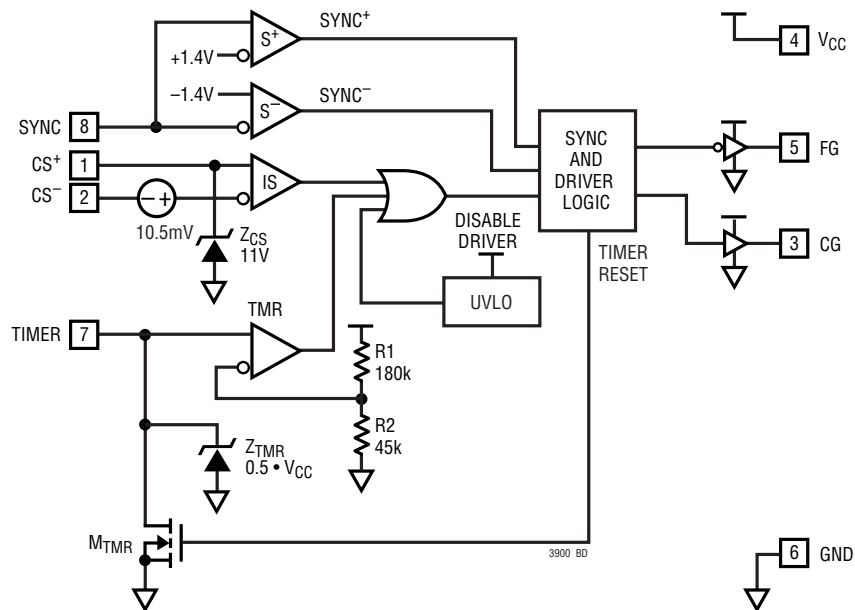

## APPLICATIONS INFORMATION

### Overview

In a typical forward converter topology, a power transformer is used to provide the functions of input/output isolation and voltage step-down to achieve the required low output voltage. Schottky diodes are often used on the secondary-side to provide rectification. Schottky diodes, though easy to use, result in a loss of efficiency due to relatively high voltage drops. To improve efficiency, synchronous output rectifiers utilizing N-channel MOSFETs can be used instead of Schottky diodes. The LTC3900 provides all of the necessary functions required to drive the synchronous rectifier MOSFETs.

Figure 1 shows a simplified forward converter application. T1 is the power transformer; Q1 is the primary-side power transistor driven by the primary controller, LT1950 GATE output. The pulse transformer T2 provides synchronization and is driven by either the inverted GATE output or a synchronization signal, SG from the primary controller. Q3 and Q4 are secondary-side synchronous switches driven by the LTC3900's FG and CG output. Inductor  $L_O$  and capacitor  $C_{OUT}$  form the output filter to provide a steady DC output voltage for the load. Also shown in Figure 1 is the feedback path from  $V_{OUT}$  through the optocoupler driver LT1797 and an optocoupler, back to the primary controller to regulate  $V_{OUT}$ .

Each full cycle of the forward converter operation consists of two periods. In the first period, Q1 turns on and the primary-side delivers power to the load through T1. SG goes low and T2 generates a negative pulse at the LTC3900 SYNC input. The LTC3900 forces FG to turn on and CG to turn off, Q3 conducts. Current flows to the load through Q3, T1 and  $L_O$ . In the next period, Q1 turns off, SG goes high and T2 generates a positive pulse at the LTC3900 SYNC input. The LTC3900 forces FG to turn off and CG to turn on, Q4 conducts. Current continues to flow to the load through Q4 and  $L_O$ . Figure 2 shows the LTC3900 synchronization waveforms.

### External MOSFET Protection

A programmable timer and a differential input current sense comparator are included in the LTC3900 for protection of the external MOSFET during power down and Burst Mode<sup>®</sup> operation. The chip also shuts off the MOSFETs if  $V_{CC} < 4.1V$ .

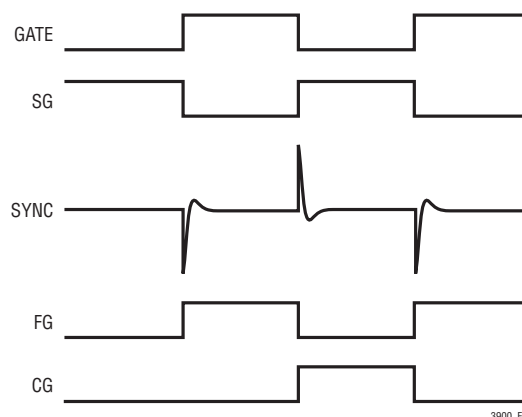

Figure 2. Synchronization Waveforms

When the primary controller is powering down, the primary controller shuts down first and the LTC3900 continues to operate for a while by drawing power from the  $V_{CC}$  bypass cap,  $C_{VCC}$ . The SG signal stops switching and there is no SYNC pulse to the LTC3900. The LTC3900 keeps one of the drivers turned on depending on the polarity of the last SYNC pulse. If the last SYNC pulse is positive, CG will remain high and the catch MOSFET, Q4 will stay on. The inductor current will start falling down to zero and continue going in the negative direction due to the voltage that is still present across the output capacitor (the current now flows from  $C_{OUT}$  back to  $L_O$ ). If Q4 is turned off while the inductor current is negative, the inductor current will produce high voltage across Q4, resulting in a MOSFET avalanche. Depending on the amount of energy stored in the inductor, this avalanche energy may damage Q4.

The timer circuit and current sense comparator in LTC3900 are used to prevent reverse current buildup in the output inductor.

### Timer

Figure 3 shows the LTC3900 timer internal and external circuits. The timer operates by using an external R-C charging network to program the time-out period. On every negative transition at the SYNC input, the chip generates a 200ns pulse to reset the timer cap. If the SYNC signal is missing or incorrect, allowing the timer cap voltage to go high, it shuts off both drivers once the voltage reaches the time-out threshold. Figure 4 shows the timer waveforms.

Burst Mode is a registered trademark of Linear Technology Corporation.

APPLICATIONS INFORMATION

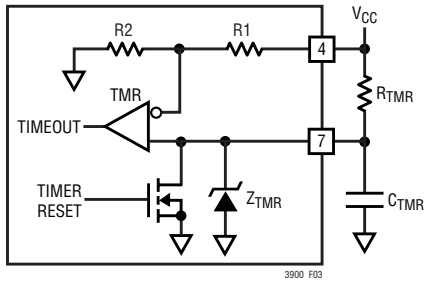

Figure 3. Timer Circuit

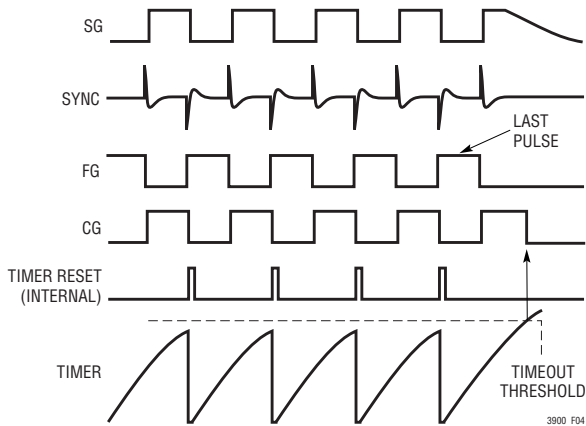

Figure 4. Timer Waveforms

A typical forward converter cycle always turns on Q3 and Q4 alternately and the SYNC input should alternate between positive and negative pulses. The LTC3900 timer also includes sequential logic to monitor the SYNC input sequence. If after one negative pulse, the SYNC comparator receives another negative pulse, the LTC3900 will not reset the timer cap. If no positive SYNC pulse appears, both drivers are shut off once the timer times out. Once positive pulses reappear the timer resets and the drivers start switching again. This is to protect the external components in situations where only negative SYNC pulse is present and FG output remains high. Figure 5 shows the timer waveforms with incorrect SYNC pulses.

The LTC3900 has two separate SYNC comparators (S<sup>+</sup> and S<sup>-</sup> in the Block Diagram) to detect the positive and negative pulses. The threshold voltages of both comparators are designed to be of the same magnitude (1.4V typical) but opposite in polarity. In some situations, for example during power up or power down, the SYNC pulse magnitude may be low, slightly higher or lower than the

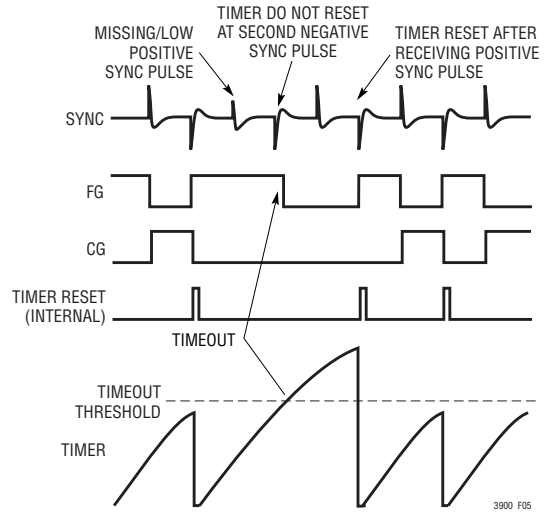

Figure 5. Timer Waveforms with Incorrect SYNC Pulses

threshold of the comparators. This can cause only one of the SYNC comparators to trip. This also appears as incorrect SYNC pulse and the timer will not reset.

The timeout period is determined by the external R<sub>TMR</sub> and C<sub>TMR</sub> values and is independent of the V<sub>CC</sub> voltage. This is achieved by making the timeout threshold a ratio of V<sub>CC</sub>. The ratio is 0.2x, set internally by R1 and R2 (see Figure 3). The timeout period should be programmed to be around 1 period of the primary switching frequency using the following formula:

$$\text{TIMEOUT} = 0.2 \cdot R_{\text{TMR}} \cdot C_{\text{TMR}} + 0.27\text{E-}6$$

To reduce error in the timeout setting due to the discharge time, select C<sub>TMR</sub> between 100pF and 1000pF. Start with a C<sub>TMR</sub> around 470pF and then calculate the required R<sub>TMR</sub>. C<sub>TMR</sub> should be placed as close as possible to the LTC3900 with minimum PCB trace between C<sub>TMR</sub>, the TIMER pin and GND. This is to reduce any ringing caused by the PCB trace inductance when C<sub>TMR</sub> discharges. This ringing may introduce error to the timeout setting.

The timer input also includes a current sinking clamp circuit (Z<sub>TMR</sub> in Figure 3) that clamps this pin to about 0.5 • V<sub>CC</sub> if there is missing SYNC/timer reset pulse. This clamp circuit prevents the timer cap from getting fully charged up to the rail, which results in a longer discharge time. The current sinking capability of the circuit is around 1mA. The timeout function can be disabled by connecting the timer pin to GND.

## APPLICATIONS INFORMATION

### Current Sense

The differential input current sense comparator is used for sensing the voltage across the drain-to-source terminals of Q4 through the CS<sup>+</sup> and CS<sup>-</sup> pins. If the inductor current reverses into the Q4 causing CS<sup>+</sup> to rise above CS<sup>-</sup> by more than 10.5mV, the LTC3900 pulls CG low. This comparator is used to prevent inductor reverse current buildup during power down or Burst Mode operation, which may cause damage to the MOSFET. The 10.5mV input threshold has a positive temperature coefficient, which closely matches the TC of the external MOSFET R<sub>DS(ON)</sub>. The current sense comparator is only active 250ns after CG goes high; this is to avoid any ringing immediately after Q4 is switched on.

Under light load conditions, if the inductor average current is less than half of its peak-to-peak ripple current, the inductor current will reverse into Q4 during a portion of the switching cycle, forcing CS<sup>+</sup> to rise above CS<sup>-</sup>. The current sense comparator input threshold is set at 10.5mV to prevent tripping under light load conditions. If the product of the inductor negative peak current and MOSFET R<sub>DS(ON)</sub> is higher than 10.5mV, the LTC3900 will operate in discontinuous current mode. Figure 6 shows the LTC3900 operating in discontinuous current mode; the CG output goes low before the next negative SYNC pulse, as soon as the inductor current becomes negative. Discontinuous current mode is sometimes undesirable. To disable discontinuous current mode operation, add a resistor divider, R<sub>CS1</sub> and R<sub>CS2</sub> at the CS<sup>+</sup> pin to increase the 10.5mV threshold so that the LTC3900 operates in continuous mode at no load.

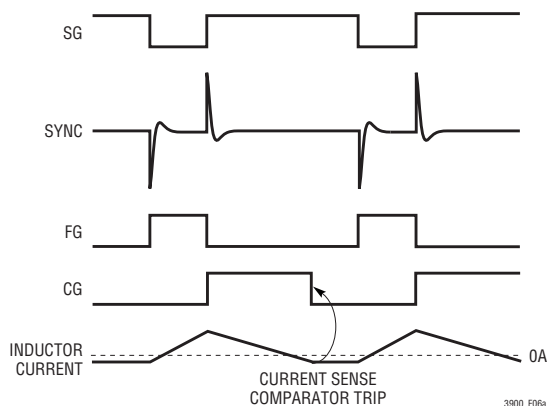

Figure 6a. Discontinuous Current Mode Operation at No Load

The LTC3900 CS<sup>+</sup> pin has an internal current sinking clamp circuit (Z<sub>CS</sub> in the Block Diagram) that clamps the pin to 11V. The clamp circuit is to be used together with the external series resistor, R<sub>CS1</sub> to protect the CS<sup>+</sup> pin from high Q4 drain voltage in the power transfer cycle. During the power transfer cycle, Q4 is off, the drain voltage of Q4 is determined by the primary input voltage and the transformer turns ratio. This voltage can be high and may damage the LTC3900 if CS<sup>+</sup> is connected directly to the drain of Q4. The current sinking capability of the clamp circuit is 5mA minimum.

The value of the resistors, R<sub>CS1</sub>, R<sub>CS2</sub> and R<sub>CS3</sub> should be calculated using the following formulas to meet both the threshold and clamp voltage requirements:

$$k = \{48 \cdot I_{\text{RIPPLE}} \cdot R_{\text{DS(ON)}}\} - 1$$

$$R_{\text{CS2}} = \{200 \cdot V_{\text{IN(MAX)}} \cdot N_{\text{S}}/N_{\text{P}} - 2200 \cdot (1 + k)\} / k$$

$$R_{\text{CS1}} = k \cdot R_{\text{CS2}}$$

$$R_{\text{CS3}} = \{R_{\text{CS1}} \cdot R_{\text{CS2}}\} / \{R_{\text{CS1}} + R_{\text{CS2}}\}$$

$$\text{If } k = 0 \text{ or less than zero, } R_{\text{CS2}} \text{ is not needed and } R_{\text{CS1}} = R_{\text{CS3}} = \{V_{\text{IN(MAX)}} \cdot (N_{\text{S}}/N_{\text{P}}) - 11\text{V}\} / 5\text{mA}$$

where:

I<sub>RIPPLE</sub> = Inductor peak-to-peak ripple current

R<sub>DS(ON)</sub> = On-resistance of Q4 at I<sub>RIPPLE</sub>/2

V<sub>IN(MAX)</sub> = Primary side main supply maximum input voltage

N<sub>S</sub>/N<sub>P</sub> = Power transformer T1, turn ratio

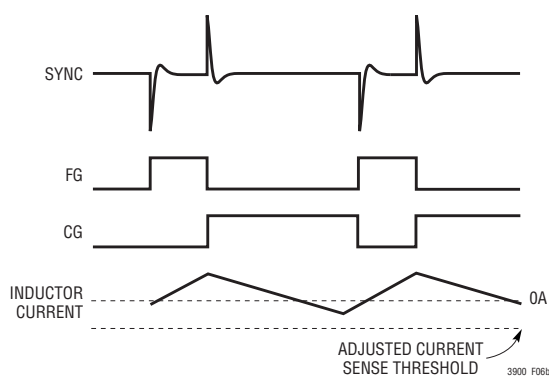

Figure 6b. Continuous Current Mode Operation with Adjusted Current Sense Threshold

## APPLICATIONS INFORMATION

If the LTC3900 still operates in discontinuous mode with the calculated resistance value, increase the value of  $R_{CS1}$  to raise the threshold. The resistors  $R_{CS1}$  and  $R_{CS2}$  and the  $CS^+$  pins input capacitance plus the PCB trace capacitance forms an R-C delay; this slows down the response time of the comparator. The resistors and  $CS^+$  input leakage currents also create an input offset error.

To minimize this delay and error, do not use resistance value higher than required and make the PCB trace from the resistors to the LTC3900  $CS^+/CS^-$  pins as short as possible. Add a series resistor,  $R_{CS3}$  with value equal to parallel sum of  $R_{CS1}$  and  $R_{CS2}$  to the  $CS^-$  pin and connect the other end of  $R_{CS3}$  directly to the source of Q4.

### SYNC Input

Figure 7 shows the external circuit for the LTC3900 SYNC input. With a selected type of pulse transformers, the values of the  $C_{SG}$  and  $R_{SYNC}$  should be adjusted to obtain a optimum SYNC pulse amplitude and width. A bigger capacitor,  $C_{SG}$ , generates a higher and wider SYNC pulse. The peak of this pulse should be much higher than the typical LTC3900 SYNC threshold of  $\pm 1.4V$ . Amplitudes greater than  $\pm 5V$  will help to speed up the SYNC comparator and reduce the SYNC to drivers propagation delay. The pulse width should be wider than 75ns. Overshoot during the pulse transformer reset interval must be minimized and kept below the minimum SYNC threshold of  $\pm 1V$ . The amount of overshoot can be reduced by having a smaller  $R_{SYNC}$ .

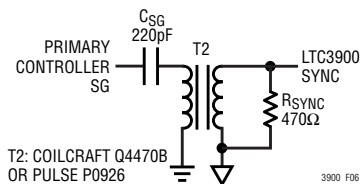

Figure 7. SYNC Input Circuit

An alternative method of generating the SYNC pulse is shown in Figure 8. This circuit produces square SYNC pulses with amplitude dependent on the logic supply voltage. The SYNC pulse width can be adjusted with R1 and C1 without affecting the pulse amplitude.

For nonisolated applications, the SYNC input can be driven directly by a bipolar square pulse. To reduce the propaga-

tion delay, make the positive and negative magnitude of the square wave much greater than the  $\pm 1.4V$  SYNC threshold.

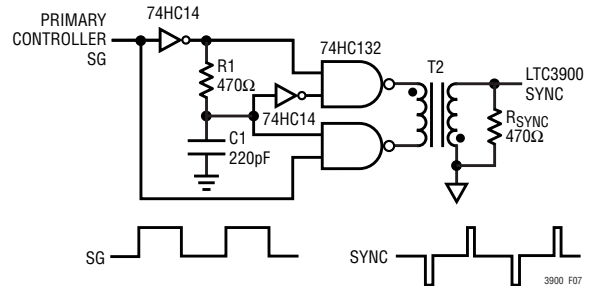

Figure 8. Symmetrical SYNC Drive

### V<sub>CC</sub> Regulator

The  $V_{CC}$  supply for the LTC3900 can be generated by peak rectifying the transformer secondary winding as shown in Figure 9. The Zener diode  $D_Z$  sets the output voltage to  $(V_Z - 0.7V)$ . A resistor,  $R_B$  (on the order of a few hundred ohms), in series with the base of  $Q_{REG}$  may be required to suppress high frequency oscillations depending on  $Q_{REG}$ 's selection.

The LTC3900 has an UVLO detector that pulls the drivers output low if  $V_{CC} < 4.1V$ . The UVLO detector has 0.5V of hysteresis to prevent chattering.

In a typical forward converter, the secondary-side circuits have no power until the primary-side controller starts operating. Since the power for biasing the LTC3900 is derived from the power transformer T1, the LTC3900 will initially remain off. During that period ( $V_{CC} < 4.1V$ ), the output rectifier MOSFETs Q3 and Q4 will remain off and the MOSFETs body diodes will conduct. The MOSFETs may experience very high power dissipation due to a high voltage drop in the body diodes. To prevent MOSFET damage,  $V_{CC}$  voltage greater than 4.1V should be provided

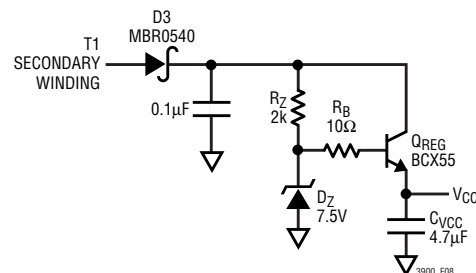

Figure 9. V<sub>CC</sub> Regulator

## APPLICATIONS INFORMATION

quickly. The  $V_{CC}$  supply circuit shown in Figure 9 will provide power for the LTC3900 within the first few switching pulses of the primary controller, preventing overheating of the MOSFETs.

### MOSFET Selection

The required MOSFET  $R_{DS(ON)}$  should be determined based on allowable power dissipation and maximum required output current.

The body diodes conduct during the power-up phase, when the LTC3900  $V_{CC}$  supply is ramping up. The CG and FG signals stay low and the inductor current flows through the body diodes. The body diodes must be able to handle the load current during start-up until  $V_{CC}$  reaches 4.1V.

The LTC3900 drivers dissipate power when switching MOSFETs. The power dissipation increases with switching frequency,  $V_{CC}$  and size of the MOSFETs. To calculate the driver dissipation, the total gate charge  $Q_G$  is used. This parameter is found on the MOSFET manufacturers data sheet.

The power dissipated in each LTC3900 MOSFET driver is:

$$P_{DRIVER} = Q_G \cdot V_{CC} \cdot f_{SW}$$

where  $f_{SW}$  is the switching frequency of the converter.

### PC Board Layout Checklist

When laying out the printed circuit board, the following checklist should be used to ensure proper operation of the LTC3900 for your layout:

1. Connect the 4.7 $\mu$ F bypass capacitor as close as possible to the  $V_{CC}$  and GND pins.
2. Connect the two MOSFET drain terminals directly to the transformer. The two MOSFET sources should be as close together as possible.
3. Keep the timer, SYNC and  $V_{CC}$  regulator circuit away from the high current path of Q3, Q4 and T1.
4. Place the timer capacitor,  $C_{TMR}$  as close as possible to the LTC3900.
5. Keep the PCB trace from the resistors  $R_{CS1}$ ,  $R_{CS2}$  and  $R_{CS3}$  to the LTC3900  $CS^+/CS^-$  pins as short as possible. Connect the other ends of the resistors directly to the drain and source of the MOSFET, Q4.

## PACKAGE DESCRIPTION

**S8 Package**  
**8-Lead Plastic Small Outline (Narrow .150 Inch)**  
 (Reference LTC DWG # 05-08-1610)

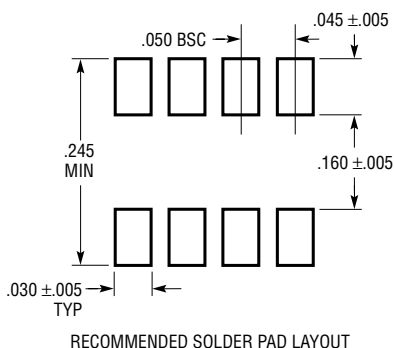

NOTE:  
 1. DIMENSIONS IN INCHES (MILLIMETERS)  
 2. DRAWING NOT TO SCALE  
 3. THESE DIMENSIONS DO NOT INCLUDE MOLD FLASH OR PROTRUSIONS. MOLD FLASH OR PROTRUSIONS SHALL NOT EXCEED .006" (0.15mm)

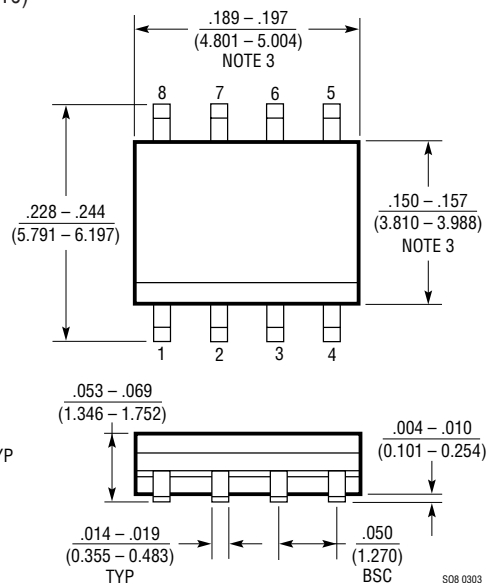
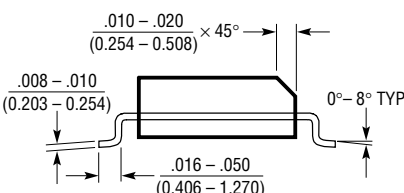

3900i

## APPLICATIONS INFORMATION

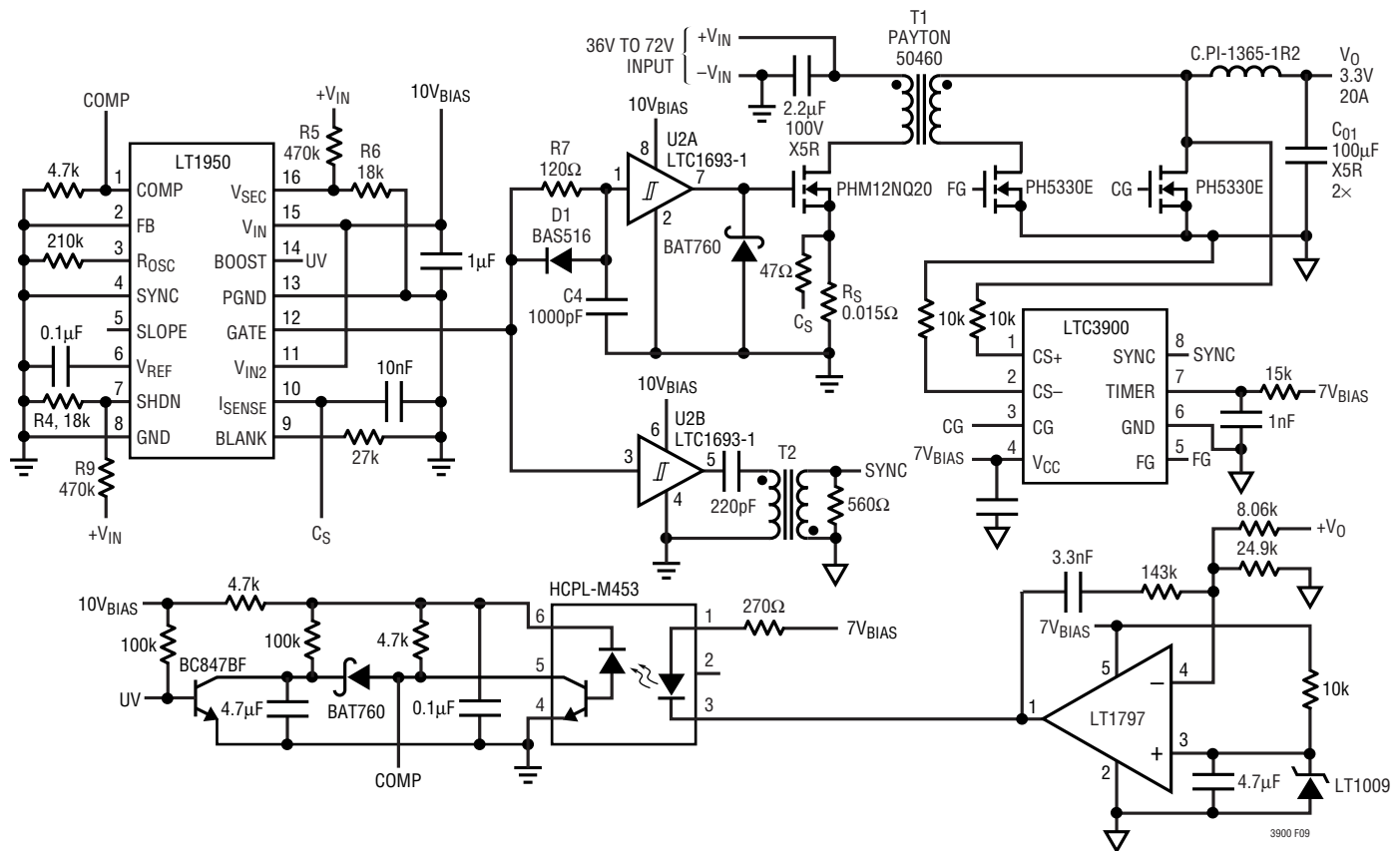

Figure 10. 36V to 72V Input to 3.3V at 20A Synchronous Forward Converter

## RELATED PARTS

PART NUMBER	DESCRIPTION	COMMENTS
LTC1693	High Speed Single/Dual N-Channel MOSFET Drivers	CMOS Compatible Input, $V_{CC}$ Range: 4.5V to 12V
LTC1698	Secondary Synchronous Rectifier Controller	Use with the LT1681, Optocoupler Driver, Pulse Transformer Synchronization
LT1950	Single Switch Controller	Used for 20W to 500W Forward Converters
LT3710	Secondary-Side Synchronous Post Regulator	For Regulated Auxiliary Output in Isolated DC/DC Converters
LT3781	"Bootstrap" Start Dual Transistor Synchronous Forward Controller	72V Operation, Synchronous Switch Output
LT3804	Secondary Side Dual Output Controller with Opto Driver	Regulates Two Secondary Outputs, Optocoupler Feedback Driver and Second Output Synchronous Driver Controller
LTC3901	Secondary-Side Synchronous Driver for Push-Pull and Full-Bridge Converter	Similar Function to LTC3900, Used in Full-Bridge and Push-Pull Converter